

## INSTALLATION INSTRUCTIONS

### TILT-OUT HAMPER

#### TOOLS REQUIRED:

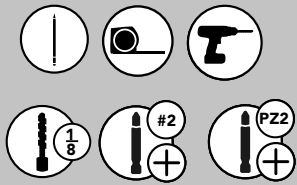

#### ESTIMATED ASSEMBLY TIME:

**25 MIN**

#### CARE AND MAINTENANCE:

Clean with a damp cloth and wipe parts dry.

WATCH TUTORIALS OF OUR PRODUCTS BEING INSTALLED



[WWW.REV-A-SHELF.COM/VIDEOS](http://WWW.REV-A-SHELF.COM/VIDEOS)



#### PARTS LIST

| No. | Description           | Qty. |
|-----|-----------------------|------|
| A   | Wire Hamper           | 1    |
| B   | Door Mount Bracket    | 1    |
| C   | #8 x 1/2" Wood Screws | 2    |
| D   | Flat Stay Hardware    | 1    |

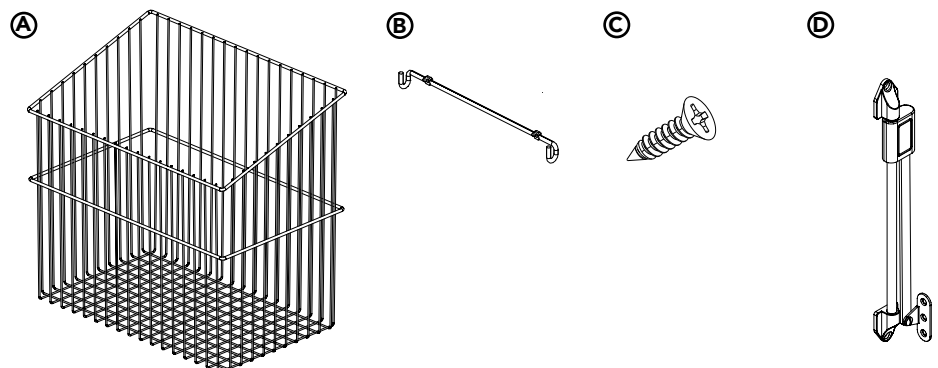

### STEP 1

From the center of your cabinet door, measure 5-15/16" (105 mm) over on either side and mark and pre-drill your door mount bracket holes using a 1/8" bit (See Figure 1).

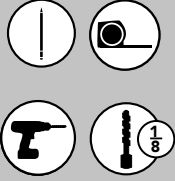

### STEP 2

Screw the door mount bracket to the door using (2) #8 x 1/2" wood screws (See Figure 2).

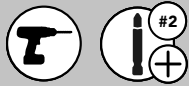

### STEP 3

Reference the flap stay instruction sheet and install the flap stay to the door and the inside of the cabinet (See Figure 3).

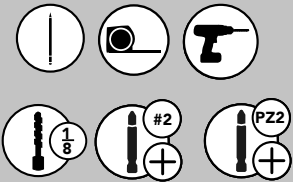

### STEP 4

Slide the wire hamper onto the door mount bracket (See Figure 4).

FIG. 1

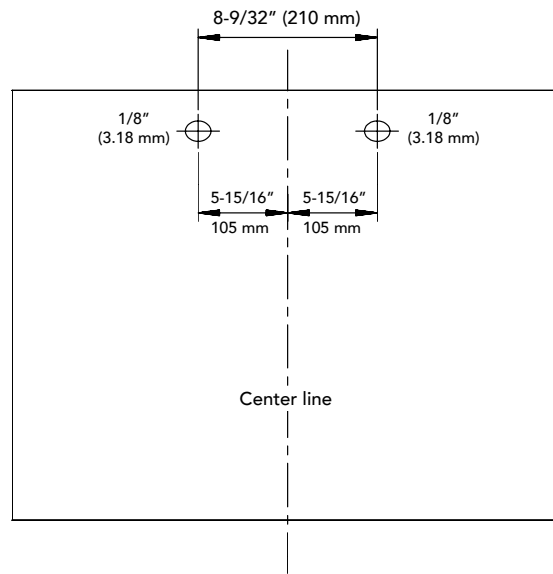

FIG. 2

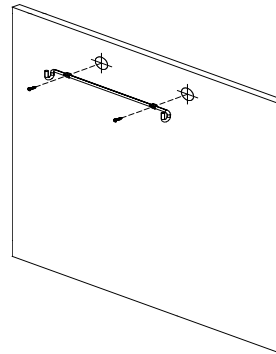

FIG. 3

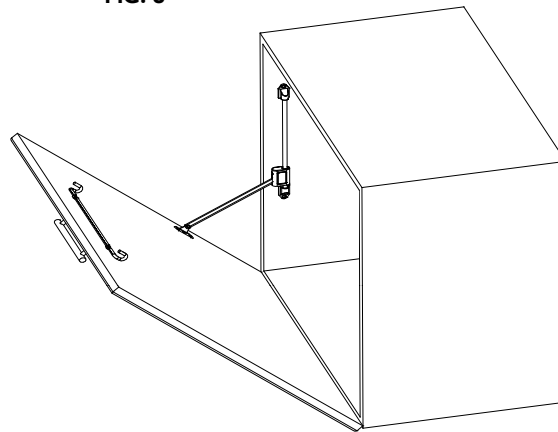
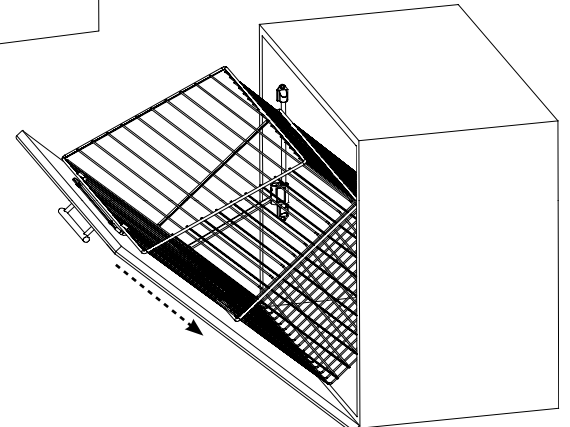

FIG. 4



## INSTRUCCIONES DE INSTALACIÓN / INSTRUCTIONS D'INSTALLATION

### CESTA INCLINABLE / PANIER BASCULANT

Herramientas requeridas:  
Outils Requis:

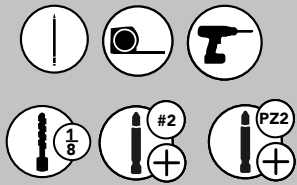

Tiempo estimado de ensamblado:  
Durée de l'installation:

# 25 MIN

#### CUIDADO/ ENTRETIEN:

Limpie con un paño húmedo y seque las partes.

Nettoyez avec un linge humide et essuyez les pièces pour les sécher complètement.

VER VIDEOS DE  
INSTALACIONES DE PRODUCTOS  
REGARDER DES VIDÉOS  
D'INSTALLATIONS DE PRODUITS



WWW.REV-A-SHELF.COM/VIDEOS



#### Lista de Partes / Liste des Pièces

| No. | Descripción / La description   | Qty. |
|-----|--|------|
| A   | <b>Cesta de alambre / Panier</b>                                       | 1    |
| B   | <b>Soporte de montaje en puerta</b><br>Support de montage sur la porte | 1    |
| C   | <b>Tornillos para madera #8 x 1/2"</b><br>Vis à bois #8 x 1/2          | 2    |
| D   | <b>Hardware de estancia plana</b><br>Quincaillerie pour support plat   | 1    |

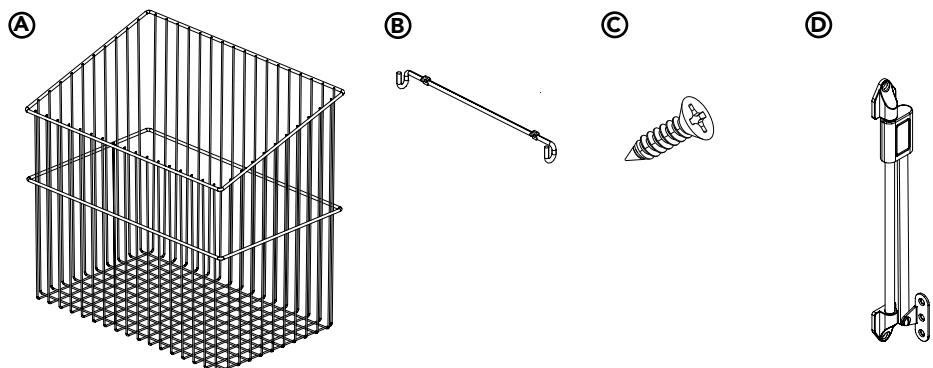

## PASO 1 / ÉTAPE 1

Desde el centro de la puerta de su armario, mida 5-15/16" (105 mm) a cada lado y marque y taladre previamente los orificios del soporte de montaje de la puerta con una broca de 1/8" (Vea Figura 1.)

À partir du centre de la porte du meuble, mesurez 5-15/16 po (105 mm) de chaque côté, et marquez et prépercez les trous du support de montage de la porte à l'aide d'une mèche de 1/8 po (voir la figure 1).

## PASO 2 / ÉTAPE 2

Atornille el soporte de montaje de la puerta a la puerta utilizando (2) tornillos de madera #8 x 1/2" (vea Figura 2).

Vissez le support de montage de porte à la porte à l'aide de deux (2) vis à bois #8 x 1/2 po (voir la figure 2).

## PASO 3 / ÉTAPE 3

Consulte la hoja de instrucciones del tirante de solapa e instale el tirante de solapa en la puerta y en el interior del gabinete (vea la Figura 3).

Référez-vous à la feuille d'instructions du support de rabat et installez le support de rabat sur la porte et l'intérieur du meuble (voir la figure 3).

## PASO 4 / ÉTAPE 4

Deslice la cesta de alambre en el soporte de montaje de la puerta (vea la Figura 4).

Faites glisser le panier sur le support de montage de la porte (voir la figure 4).

FIG. 1

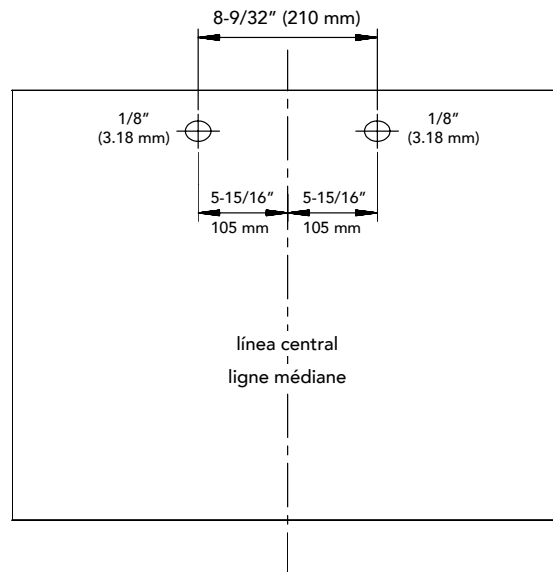

FIG. 2

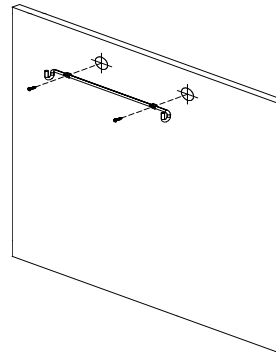

FIG. 3

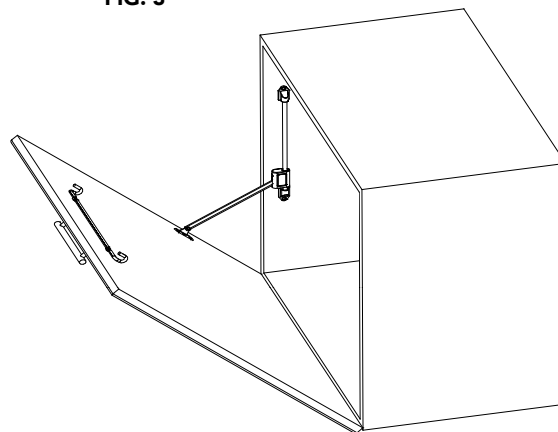

FIG. 4

