

POCKET DOOR SYSTEM (INSET)

ALT-ST15-D360

LATERAL OPEN
CABINET HARDWARE

POCKET DOOR SYSTEM



- Create a clean design with doors that can conveniently pocket away.
- Can manage doors up to 63" (1600mm) tall weighing up to 33 lbs (15 kg).
- 5-speed adjustable soft-closing dampers (Uses 360 Olympia Hinges).
- 5-stage angle adjustment eliminating sagging doors.
- L-Shaped connecting plate minimizing racking and reduces door sag.
- Available slide lengths: 16", 19", 22", 24" and 28".
- Durability: successfully passed 40,000 open/close private cycles.

Installation

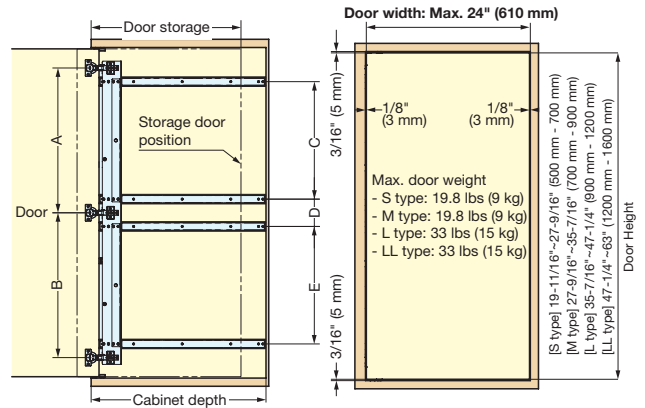

Easy Door Alignment Adjustment

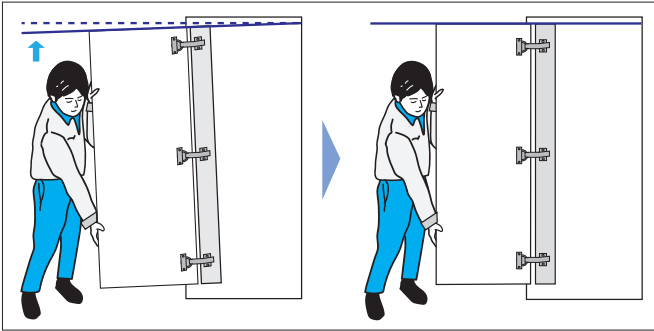

When installing, you can adjust the hanging angle just by lifting up the door.

Installation Example (Key on page 591)

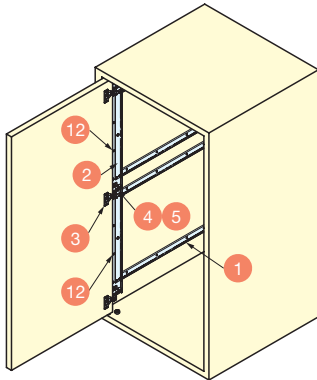

- Number of slides
- S type : 2
- M type : 2
- L type : 4
- LL type : 4

Door Cut Out Dimensions

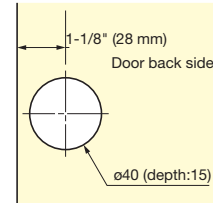

Last Digits of Item Name (Parts Set)	Door Storage Amount	Min. Cabinet Depth
16	12-7/16" (316 mm) + Thickness	16-1/4" (412 mm) + Thickness
19	15-7/16" (392 mm) + Thickness	19-3/16" (488 mm) + Thickness
22	18-7/16" (468 mm) + Thickness	22-3/16" (564 mm) + Thickness
24	20-7/16" (519 mm) + Thickness	24-3/16" (615 mm) + Thickness
28	24-7/16" (621 mm) + Thickness	28-1/4" (717 mm) + Thickness

	ALT-ST15-D360S (2 slides)	ALT-ST15-D360M (2 slides)	ALT-ST15-D360L (4 slides)	ALT-ST15-D360LL (4 slides)
Door Width	Max. 24" (610 mm)			
Door Height	19-11/16"~27-9/16" (500 - 700 mm)	27-9/16"~35-7/16" (700 - 900 mm)	35-7/16"~47-1/4" (900 - 1200 mm)	47-1/4"~63" (1200 - 1600 mm)
Door Thickness	11/16"~1-3/16" (18 - 30 mm)			
Door Weight	Max. 19.8 lbs (9 kg)		Max. 33 lbs (15 kg)	

Type	Hinge Placement			Slide Placement		
	A	B	C	D	E	
S Type	14-3/16" (360 mm)	-	10-1/4" (260 mm)	-	-	-
M Type	22-1/16" (560 mm)	-	18-1/8" (460 mm)	-	-	-
L Type	14-15/16" (380 mm)	14-15/16" (380 mm)	10-1/4" (260 mm)	5-1/2" (140 mm)	10-1/4" (260 mm)	
LL Type	20-7/8" (530 mm)	20-7/8" (530 mm)	16-15/16" (430 mm)	3-15/16" (100 mm)	16-15/16" (430 mm)	

How to Order ALT-ST15-D360

Parts set Not optional. Each set includes required parts.

Type	Door Spec (Thickness: 11/16" ~ 1-3/16" (18-30 mm))	C Door Storage	D Min. Cabinet Depth	Item Name
S	<p>W= Max. 24" (610 mm) Weight= Max. 19.8 lbs (9 kg) H= 19-11/16"~27-9/16" (500-700 mm)</p>	12-3/8" (315 mm)	16-9/16" (420 mm)	ALT-ST15-D360S-16
		15-3/8" (391 mm)	19-1/2" (496 mm)	ALT-ST15-D360S-19
		18-3/8" (467 mm)	22-1/2" (572 mm)	ALT-ST15-D360S-22
		20-3/8" (518 mm)	24-1/2" (623 mm)	ALT-ST15-D360S-24
		24-7/16" (620 mm)	28-9/16" (725 mm)	ALT-ST15-D360S-28
M	<p>W= Max. 24" (610 mm) Weight= Max. 19.8 lbs (9 kg) H= 27-9/16"~35-7/16" (700-900 mm)</p>	12-3/8" (315 mm)	16-9/16" (420 mm)	ALT-ST15-D360M-16
		15-3/8" (391 mm)	19-1/2" (496 mm)	ALT-ST15-D360M-19
		18-3/8" (467 mm)	22-1/2" (572 mm)	ALT-ST15-D360M-22
		20-3/8" (518 mm)	24-1/2" (623 mm)	ALT-ST15-D360M-24
		24-7/16" (620 mm)	28-9/16" (725 mm)	ALT-ST15-D360M-28
L	<p>W= Max. 24" (610 mm) Weight= Max. 33 lbs (15 kg) H= 35-7/16"~47-1/4" (900-1200 mm)</p>	12-3/8" (315 mm)	16-9/16" (420 mm)	ALT-ST15-D360L-16
		15-3/8" (391 mm)	19-1/2" (496 mm)	ALT-ST15-D360L-19
		18-3/8" (467 mm)	22-1/2" (572 mm)	ALT-ST15-D360L-22
		20-3/8" (518 mm)	24-1/2" (623 mm)	ALT-ST15-D360L-24
		24-7/16" (620 mm)	28-9/16" (725 mm)	ALT-ST15-D360L-28
LL	<p>W= Max. 24" (610 mm) Weight= Max. 33 lbs (15 kg) H= 47-1/4"~63" (1200-1600 mm)</p>	12-3/8" (315 mm)	16-9/16" (420 mm)	ALT-ST15-D360LL-16
		15-3/8" (391 mm)	19-1/2" (496 mm)	ALT-ST15-D360LL-19
		18-3/8" (467 mm)	22-1/2" (572 mm)	ALT-ST15-D360LL-22
		20-3/8" (518 mm)	24-1/2" (623 mm)	ALT-ST15-D360LL-24
		24-7/16" (620 mm)	28-9/16" (725 mm)	ALT-ST15-D360LL-28

Item Name of Parts Set

ALT-ST15-D360 S - 16

Type name

Slide Length

Installation of Slide

Slide/hinge mounting

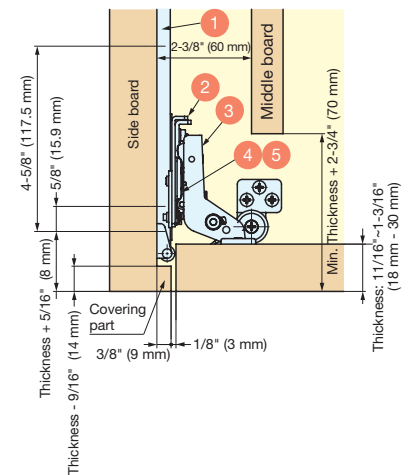

To hide the metal fittings, install a middle board (not included).
(An attachable/detachable middle board is recommended for easier maintenance.)

For roller bracket mounting

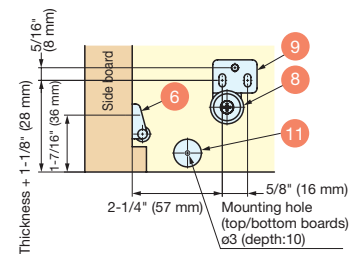

For mounting with female screw

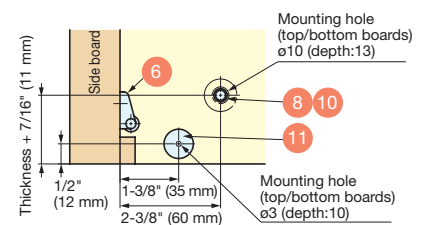

ALT-ST15-D360 Parts Set Details

The following 1 - 19 show detailed information on the set codes included on the previous page.

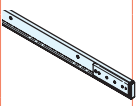
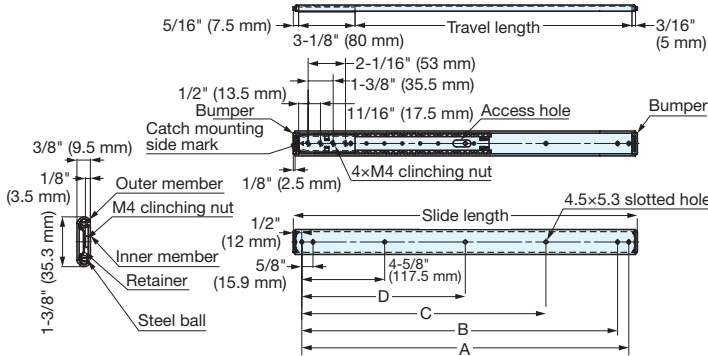
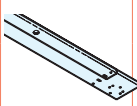
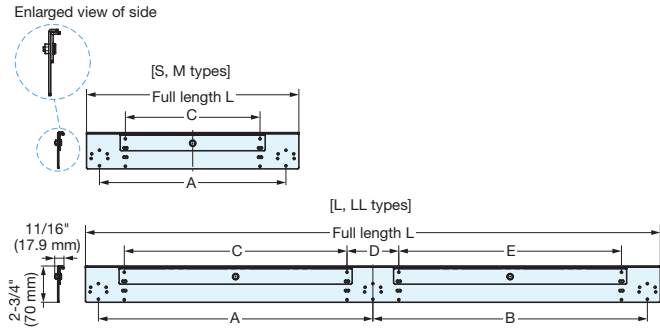
No.	Qty				Parts	Dimensions	Item Name																																									
	S	M	L	LL																																												
1	2	4	 <p>The item number with the same last digits as those of the set item number is included in each set. Mount the track so that the catch mounting side mark is located on the front side of the cabinet.</p>			AL80C-16																																										
						AL80C-19																																										
						AL80C-22																																										
						AL80C-24																																										
						AL80C-28																																										
						<table border="1"> <thead> <tr> <th>Item Name</th> <th>Slide Length</th> <th>Travel Length</th> <th>Door Storage</th> <th>A</th> <th>B</th> <th>C</th> <th>D</th> </tr> </thead> <tbody> <tr> <td>AL80C-16</td> <td>16-3/16" (411.4 mm)</td> <td>12-7/16" (316.4 mm)</td> <td>12-3/8" (315 mm)</td> <td>-</td> <td>15-1/4" (387.4 mm)</td> <td>14-5/8" (371.5 mm)</td> <td>10-5/8" (269.9 mm)</td> </tr> <tr> <td>AL80C-19</td> <td>19-3/16" (487.6 mm)</td> <td>15-7/16" (392.6 mm)</td> <td>15-3/8" (391 mm)</td> <td>17-3/16" (436.6 mm)</td> <td>17-3/16" (447.7 mm)</td> <td>13-5/8" (346.1 mm)</td> <td>9-1/8" (231.8 mm)</td> </tr> <tr> <td>AL80C-22</td> <td>22-3/16" (563.8 mm)</td> <td>18-7/16" (468.8 mm)</td> <td>18-3/8" (467 mm)</td> <td>21-1/4" (539.8 mm)</td> <td>20-5/8" (523.9 mm)</td> <td>16-5/8" (422.3 mm)</td> <td>10-5/8" (269.9 mm)</td> </tr> <tr> <td>AL80C-24</td> <td>24-3/16" (614.6 mm)</td> <td>20-7/16" (519.6 mm)</td> <td>20-3/8" (518 mm)</td> <td>23-1/4" (590.6 mm)</td> <td>22-5/8" (574.7 mm)</td> <td>18-5/8" (473.1 mm)</td> <td>11-5/8" (295.3 mm)</td> </tr> <tr> <td>AL80C-28</td> <td>28-3/16" (716.2 mm)</td> <td>24-7/16" (621.2 mm)</td> <td>24-7/16" (620 mm)</td> <td>28" (711.2 mm)</td> <td>26-5/8" (676.3 mm)</td> <td>22-5/8" (574.7 mm)</td> <td>13-5/8" (346.1 mm)</td> </tr> </tbody> </table> <p>Material: Steel Finish: Chromate</p>	Item Name	Slide Length	Travel Length	Door Storage	A	B	C	D	AL80C-16	16-3/16" (411.4 mm)	12-7/16" (316.4 mm)	12-3/8" (315 mm)	-	15-1/4" (387.4 mm)	14-5/8" (371.5 mm)	10-5/8" (269.9 mm)	AL80C-19	19-3/16" (487.6 mm)	15-7/16" (392.6 mm)	15-3/8" (391 mm)	17-3/16" (436.6 mm)	17-3/16" (447.7 mm)	13-5/8" (346.1 mm)	9-1/8" (231.8 mm)	AL80C-22	22-3/16" (563.8 mm)	18-7/16" (468.8 mm)	18-3/8" (467 mm)	21-1/4" (539.8 mm)	20-5/8" (523.9 mm)	16-5/8" (422.3 mm)	10-5/8" (269.9 mm)	AL80C-24	24-3/16" (614.6 mm)	20-7/16" (519.6 mm)	20-3/8" (518 mm)	23-1/4" (590.6 mm)	22-5/8" (574.7 mm)	18-5/8" (473.1 mm)	11-5/8" (295.3 mm)	AL80C-28	28-3/16" (716.2 mm)
Item Name	Slide Length	Travel Length	Door Storage	A	B	C	D																																									
AL80C-16	16-3/16" (411.4 mm)	12-7/16" (316.4 mm)	12-3/8" (315 mm)	-	15-1/4" (387.4 mm)	14-5/8" (371.5 mm)	10-5/8" (269.9 mm)																																									
AL80C-19	19-3/16" (487.6 mm)	15-7/16" (392.6 mm)	15-3/8" (391 mm)	17-3/16" (436.6 mm)	17-3/16" (447.7 mm)	13-5/8" (346.1 mm)	9-1/8" (231.8 mm)																																									
AL80C-22	22-3/16" (563.8 mm)	18-7/16" (468.8 mm)	18-3/8" (467 mm)	21-1/4" (539.8 mm)	20-5/8" (523.9 mm)	16-5/8" (422.3 mm)	10-5/8" (269.9 mm)																																									
AL80C-24	24-3/16" (614.6 mm)	20-7/16" (519.6 mm)	20-3/8" (518 mm)	23-1/4" (590.6 mm)	22-5/8" (574.7 mm)	18-5/8" (473.1 mm)	11-5/8" (295.3 mm)																																									
AL80C-28	28-3/16" (716.2 mm)	24-7/16" (621.2 mm)	24-7/16" (620 mm)	28" (711.2 mm)	26-5/8" (676.3 mm)	22-5/8" (574.7 mm)	13-5/8" (346.1 mm)																																									
2	1	 <p>The end of the item number indicates the corresponding size.</p>			ALT-ST15-S																																											
					ALT-ST15-M																																											
					ALT-ST15-L																																											
					ALT-ST15-LL																																											
					<table border="1"> <thead> <tr> <th rowspan="2">Item Name</th> <th colspan="2">Hinge Placement</th> <th colspan="3">Slide Placement</th> <th rowspan="2">Full Length L</th> </tr> <tr> <th>A</th> <th>B</th> <th>C</th> <th>D</th> <th>E</th> </tr> </thead> <tbody> <tr> <td>ALT-ST15-S</td> <td>14-3/16" (360 mm)</td> <td>-</td> <td>10-1/4" (260 mm)</td> <td>-</td> <td>-</td> <td>16-1/8" (410 mm)</td> </tr> <tr> <td>ALT-ST15-M</td> <td>22-1/16" (560 mm)</td> <td>-</td> <td>18-1/8" (460 mm)</td> <td>-</td> <td>-</td> <td>24" (610 mm)</td> </tr> <tr> <td>ALT-ST15-L</td> <td>14-15/16" (380 mm)</td> <td>14-15/16" (380 mm)</td> <td>10-1/4" (260 mm)</td> <td>5-1/2" (140 mm)</td> <td>10-1/4" (260 mm)</td> <td>31-7/8" (810 mm)</td> </tr> <tr> <td>ALT-ST15-LL</td> <td>20-7/8" (530 mm)</td> <td>20-7/8" (530 mm)</td> <td>16-15/16" (430 mm)</td> <td>3-15/16" (100 mm)</td> <td>16-15/16" (430 mm)</td> <td>43-11/16" (1110 mm)</td> </tr> </tbody> </table> <p>Material: Aluminum Alloy Finish: Silver Anodized</p>	Item Name	Hinge Placement		Slide Placement			Full Length L	A	B	C	D	E	ALT-ST15-S	14-3/16" (360 mm)	-	10-1/4" (260 mm)	-	-	16-1/8" (410 mm)	ALT-ST15-M	22-1/16" (560 mm)	-	18-1/8" (460 mm)	-	-	24" (610 mm)	ALT-ST15-L	14-15/16" (380 mm)	14-15/16" (380 mm)	10-1/4" (260 mm)	5-1/2" (140 mm)	10-1/4" (260 mm)	31-7/8" (810 mm)	ALT-ST15-LL	20-7/8" (530 mm)	20-7/8" (530 mm)	16-15/16" (430 mm)	3-15/16" (100 mm)	16-15/16" (430 mm)	43-11/16" (1110 mm)			
Item Name	Hinge Placement		Slide Placement				Full Length L																																									
	A	B	C	D	E																																											
ALT-ST15-S	14-3/16" (360 mm)	-	10-1/4" (260 mm)	-	-	16-1/8" (410 mm)																																										
ALT-ST15-M	22-1/16" (560 mm)	-	18-1/8" (460 mm)	-	-	24" (610 mm)																																										
ALT-ST15-L	14-15/16" (380 mm)	14-15/16" (380 mm)	10-1/4" (260 mm)	5-1/2" (140 mm)	10-1/4" (260 mm)	31-7/8" (810 mm)																																										
ALT-ST15-LL	20-7/8" (530 mm)	20-7/8" (530 mm)	16-15/16" (430 mm)	3-15/16" (100 mm)	16-15/16" (430 mm)	43-11/16" (1110 mm)																																										

*For information on how to mount the parts and the quantities of the parts included in each parts set, please see the instructions.

ALT-ST15-D360 Parts Set Details

The following ①-⑬ show detailed information on the set codes included on the previous page.

No.	Qty				Parts	Dimensions	Item Name							
	S	M	L	LL										
③	2		3		Hinge body (with built-in damper)		H360-D26-0T	Material: Steel Finish: Nickel						
④	2		3		Hinge mounting plate		360-P4W-30T	Material: Steel Finish: Nickel						
⑤	2		3		Mounting plate		ALT-MP30	Material: Stainless Steel Finish: Barrel Polished						
⑥	2		3		Guide roller	<p>Cross sectional view X-X</p>	ALT-GR	Material: Steel/Ethylene Propylene Rubber (EPDM) Finishing/Color: Nickel/White						
⑦ - ⑫			1		Parts set		<table border="1"> <tr> <td>S type</td> <td rowspan="2">ALT-ST15-D10-MP</td> </tr> <tr> <td>M type</td> </tr> <tr> <td>L type</td> <td rowspan="2">ALT-ST15-D10-LLP</td> </tr> <tr> <td>LL type</td> </tr> </table>	S type	ALT-ST15-D10-MP	M type	L type	ALT-ST15-D10-LLP	LL type	Necessary types and numbers of screws and hexagon wrenches are included.
S type	ALT-ST15-D10-MP													
M type														
L type	ALT-ST15-D10-LLP													
LL type														

*For information on how to mount the parts and the quantities of the parts included in each parts set, please see the instructions.









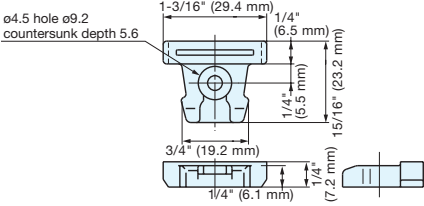

*1 The mounting plates in the images and drawings are not included in the set.

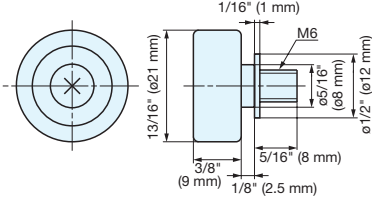
ALT-ST15, ALT-ST20 Parts Set Details

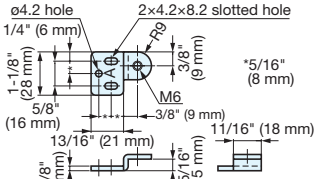
Detailed information on the parts sets used for ALT-ST15 and ALT-ST20

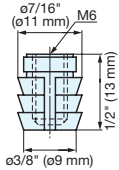
LATERAL OPEN
CABINET HARDWARE

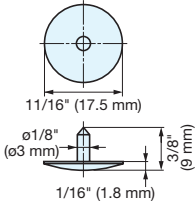
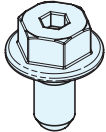
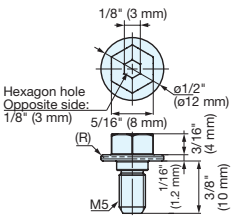
POCKET DOOR SYSTEM

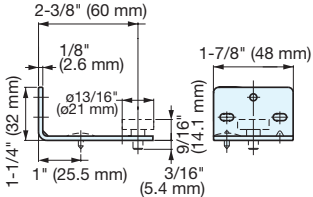
Qty		Parts	Dimensions	Item Name
S type	M type			
2		3	  <p> Catch ø4.5 hole ø9.2 countersunk depth 5.6 1-3/16" (29.4 mm) 1/4" (6.5 mm) 1/4" (6.5 mm) 15/16" (23.2 mm) 3/4" (19.2 mm) 1/4" (6.1 mm) 1/4" (7.2 mm) </p>	AL127-CH Material: Polyurethane (PUR) Color: Black
2			  <p> Roller 1/16" (1 mm) M6 13/16" (21 mm) 5/16" (8 mm) 3/8" (9 mm) 1/8" (2.5 mm) ø5/16" (8 mm) ø1/2" (12 mm) </p>	DU19-B4SBR Material: Ethylene Propylene Rubber (EPDM)/Steel Finishing/Color: Gloss Chromate/White
Left/Right 1 each			  <p> Roller bracket* ø4.2 hole 1/4" (6 mm) 2x4.2x8.2 slotted hole 1-1/8" (28 mm) 5/8" (16 mm) 3/8" (9 mm) 11/16" (18 mm) 1/8" (3 mm) 5/16" (8 mm) M6 7/8" (18 mm) † The drawing shows A type (bottom right/upper left) </p>	ALT-2V-AB † Type A (bottom right/ upper left) ALT-2V-BB † Type B (upper right/bottom left) Material: Steel Finish: Colored Chromate
2			  <p> Insert female screw* ø7/16" (11 mm) M6 1/2" (13 mm) ø3/8" (9 mm) </p>	SC-107-13 Material: Polyamide (PA) Color: White
2			  <p> G-type sliding tack 11/16" (17.5 mm) ø1/8" (3 mm) 3/8" (9 mm) 1/16" (1.8 mm) </p>	G-175 Material: Polyethylene (PE) Color: Natural
1		2	  <p> Adjustment bolt 1/8" (3 mm) Hexagon hole Opposite side: 1/8" (3 mm) 5/16" (8 mm) 1/16" (1.2 mm) 1/16" (1.2 mm) 3/8" (10 mm) ø1/2" (12 mm) M5 </p>	ALT-AB M5 Material: Steel (SWCH) Finishing/Color: Colored Chromate (Trivalent)/White Dedicated bolt for hanging adjustment
1			  <p> Anti-vibration bracket To keep distance between door and floor surface (e.g., laundry room). 2-3/8" (60 mm) 1/8" (2.6 mm) 1-7/8" (48 mm) 9/16" (14.1 mm) 3/16" (5.4 mm) 1-1/4" (32 mm) 1" (25.5 mm) </p>	ALT-BR Material: Steel Finish: Colored Chromate (trivalent)

*Use either roller bracket or insert female screw, depending on the mounting method.