

This product is covered by U.S. and various foreign patents issued and/or pending. Not recommended for applications where beaded moldings are used.

For use with model
3132EC Easy-Close

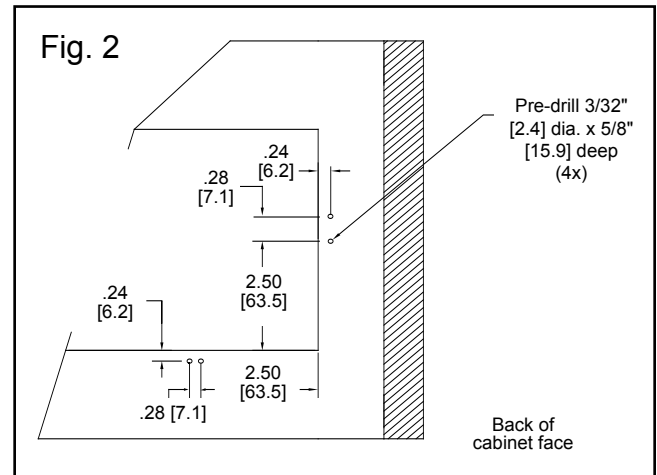
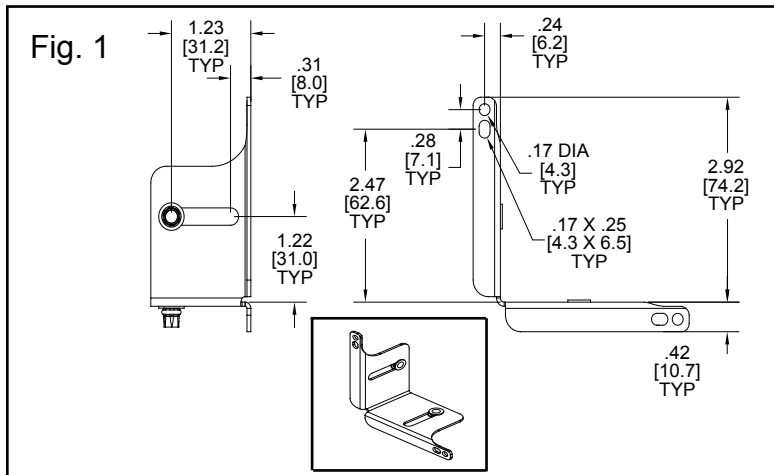

PREPARATION

For the rear face frame bracket, order kit #4180-0560-XE separately. Refer to figure 1 of the rear face frame installation guide and attach the rear bracket to the slide.

FIGURE 2

Pre-drill 3/32" [2.4] dia. holes as shown on both sides of the cabinet.

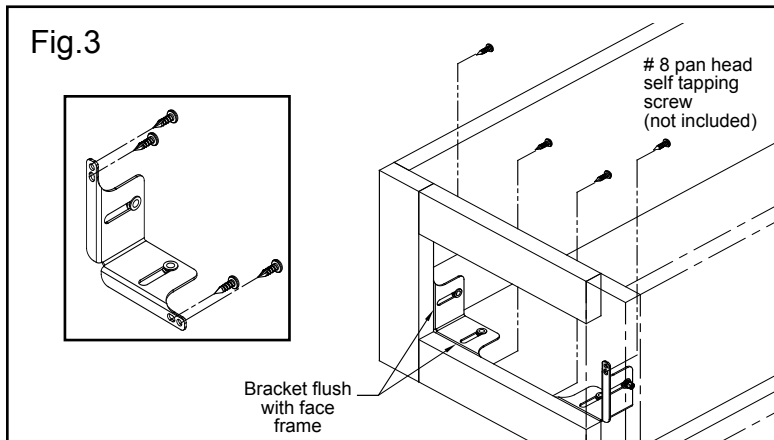

FIGURE 3

Position the inset brackets flush with cabinet's front face frame. Install using #8 pan head screw (not provided).

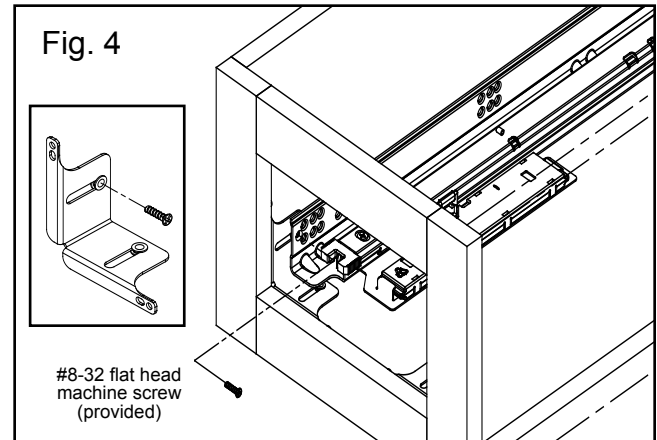

FIGURE 4

Install front of slide to the front inset bracket loosely using the #8/32 flat head machine screws that are provided in the kit.

Note: Do not tighten the screw until slide is properly positioned.

Refer back to the rear face frame bracket installation guide and follow procedures for figures 3 and 4. The inset bracket slots provide for a flush inset drawer front. Locate slides based on desired drawer front position. Tighten the 8-32 machine screw to fix the slide location and complete the installation.

Ordering/Packaging Information

Inset face frame brackets are ordered as a kit or in bulk. Kits are packaged 60 per box. Brackets are provided in zinc finish. Mounting screws are not included.

To order the kit, specify part number 4180-0604-XE. Each kit contains 2 inset bracket assemblies, 2 each #8-32 flat head screws and an installation guide in a polybag.

To order in bulk, specify part number 4180-0620-XE. Brackets are packed 120 each per box.

Note: RoHs Compliant.

Specifications, materials, prices, terms, and delivery are subjected to change without notice.