

**PRECISION
WOODWORKING**

LAGUNA

Revo 18|36 Lathe



Owner's Manual
MLAREVO 1836-110-150
MLAREVO 1836-220
2/19/2021

256540

Laguna takes pride in our products and stands behind them with continuing service and support for our customers. Your Laguna machine was designed to bring a new dimension of productivity to your shop.

Before using your machine for the first time, learn how to use it. This manual covers a step-by-step process of assembly and machine operation. If you have any questions, this manual will provide answers.

We do our best to thoroughly document every product that we sell for customer reference. Several files are compiled to cover all components of a machine.

Several machines may be covered by one manual.

Many machines sold by Laguna include components with independent owners' manuals.

The information contained in this publication was correct at the time of print. In the interest of continuous innovation, we reserve the right to change specifications, design or included equipment without notice or obligation. No part of this publication may be reproduced, transmitted, or translated into any language in any form by any means without our written permission. Errors and omissions may be current.

Laguna Tools, Inc. LAGUNA® and the LAGUNA Logo® are the registered trademarks of Laguna Tools, Inc. All rights reserved. 04/01/2019

LAGUNA

LAGUNA AMERICAN HEADQUARTERS

Texas: 744 Refuge Way Suite 200, Grand Prairie, Texas 75050, U.S.A. Phone: +1-800-332-4094

Huntington Beach: 7291 Heil Ave Huntington Beach, CA 92647, U.S.A. Phone: +1-949-474-1200

South Carolina: 825 Bistline Dr. Ste 101, West Columbia, SC 29172, U.S.A. Phone: +1-800-234-1976

Minnesota: 5250 West 74th St, Edina, MN 55439, U.S.A. Phone: +1-949-474-1200

lagunatools.com

supermaxtools.com

lagunacleanair.com

lagunalathe.com

LAGUNA EUROPE

Walker Rd, Bardon Hill, Coalville LE67 1TU, United Kingdom. Phone: +44-1530-516921

lagunatools.uk

DAKE CORPORATION

724 Robbins Road, Grand Haven, MI 49417, United States +1-800-937-3253

dakecorp.com

Table of Contents



Safety	4
Electrical Safety	10
Specifications	14
Machine Overview	15
Setup	21
Videos	21
Placement & Unboxing	23
Inventory List	27
Assembling the Lathe	29
Standard Accessories	34
Adjustments	38
Maintenance	43
Troubleshooting	44
Wiring	45
Replacement Parts Diagram	46
Replacement Parts Table	48
Warranty	53



Safety



Read and understand all warnings and operation instructions before using any tool or equipment. Always follow basic safety precautions to reduce the risk of personal injury. Improper operation, maintenance or modification of tools or equipment could result in serious injury and property damage. There are certain applications for which tools and equipment are designed. This product should NOT be modified and/or used for any application other than for which it was designed.

It is important for you to read and understand this manual. The information it contains relates to protecting your safety and preventing problems.

Safety Call-outs











 **DANGER** An imminently hazardous situation which, if not avoided, will result in death or serious injury. Sometimes displayed as  **DANGER!**

 **WARNING** A potentially hazardous situation which, if not avoided, could result in death or serious injury. Sometimes displayed as  **WARNING!**

 **CAUTION** A potentially hazardous situation which, if not avoided, may result in minor or moderate injury. Sometimes displayed as  **CAUTION!**

 **NOTICE** A helpful tip from our technical staff. Sometimes displayed as **NOTICE!**

Safety Symbols

-  Disconnect from power before proceeding.
-  Wear ear protection.
-  Be aware of possible laceration danger.
-  Wear Eye Protection.
-  Be aware of possible crushing danger.
-  Wear a full face shield.
-  Be aware of possible crushing danger.
-  Wear lung protection.
-  Electrical Hazard.
-  Requires X People

**WARNING****Important Safety Instructions**

Read and understand all warnings and operating instructions before using this equipment. Failure to follow all instructions listed below, may result in electric shock, fire, and/or serious personal injury or property damage.

Woodworking can be dangerous if safe and proper operating procedures are not followed. As with all machinery, there are certain hazards involved with the operation of the product. Using the machine with respect and caution will considerably lessen the possibility of personal injury. However, if normal safety precautions are overlooked or ignored, personal injury to the operator may result. Safety equipment such as guards, push sticks, hold-downs, feather boards, goggles, dust masks and hearing protection can reduce your potential for injury. But even the best guard won't make up for poor judgment, carelessness or inattention. Always use common sense and exercise caution in the workshop. If a procedure feels dangerous, don't try it. Figure out an alternative procedure that feels safer. REMEMBER: Your personal safety is your responsibility.

This machine was designed for certain applications only. We strongly recommend that this machine not be modified and/or used for any application other than that for which it was designed. If you have any questions relative to a particular application, do not use the machine until you have first contacted the manufacturer to determine if it can or should be performed on the product.

If you have any questions relative to its application do not use the product until you have contacted the manufacturer and we have advised you.

General Safety Rules

FAILURE TO FOLLOW THESE RULES MAY RESULT IN SERIOUS PERSONAL INJURY.

FOR YOUR OWN SAFETY, READ AND UNDERSTAND THE INSTRUCTION MANUAL BEFORE OPERATING THE MACHINE. Learn the unit's application and limitations as well as the specific hazards peculiar to it.

KEEP WORK AREA CLEAN. Cluttered areas and benches invite accidents.

DON'T USE IN DANGEROUS ENVIRONMENT. Don't use this unit in damp or wet locations or expose it to rain. Keep work area well-lighted.

KEEP CHILDREN AND VISITORS AWAY. All children and visitors should be kept a safe distance from work area.

DISCONNECT UNIT before servicing.

CHECK DAMAGED PARTS. Before further use of the unit, properly repair or replace any part that is damaged.

Safety Rules: Wood Turning Lathe

"WARNING" For Your Own Safety Read Instruction Manual before Operating Lathe

- a) Wear eye protection.
- b) Do not wear gloves, a necktie, or loose clothing.
- c) Tighten all locks before operating.
- d) Rotate work piece by hand before applying power.

- e) Rough out work piece before installing on faceplate.
 - f) Do not mount split work piece or one containing a knot.
 - g) Use lowest speed when starting new work piece.
-
1. KEEP GUARDS IN PLACE and in working order.
 2. REMOVE ADJUSTING KEYS AND WRENCHES. Form habit of checking to see that keys and adjusting wrenches are removed from tool before turning it on.
 3. KEEP WORK AREA CLEAN. Cluttered areas and benches invite accidents.
 4. DON'T USE IN A DANGEROUS ENVIRONMENT. Don't use power tools in damp or wet locations, or expose them to rain. Keep work area well lighted.
 5. KEEP CHILDREN AWAY. All visitors should be kept at a safe distance from the work area.
 6. MAKE YOUR WORKSHOP KID PROOF with padlocks, master switches, or by removing starter keys.
 7. DON'T FORCE TOOL. It will do the job better and safer at the rate for which it was designed.
 8. USE RIGHT TOOL. Don't force tool or attachment to do a job for which it was not designed.
 9. USE PROPER EXTENSION CORD. Make sure your extension cord is in good condition. When using an extension cord, be sure to use one heavy enough to carry the current your product will draw. An undersized cord will cause a drop in line voltage resulting in loss of power and overheating. Table A shows the correct size to use depending on cord length and nameplate ampere rating. If in doubt, use the next heavier gauge. The smaller the gauge number, the heavier the chord.
 10. WEAR PROPER APPAREL Do not wear loose clothing, gloves, neckties, rings, bracelets, or other jewelry which may get caught in moving parts. Nonslip footwear is recommended. Wear protective hair covering to contain long hair.
 11. ALWAYS USE SAFETY GLASSES. Also use a face or dust mask if cutting operation is dusty. Everyday eyeglasses only have impact resistant lenses, they are NOT safety glasses.
 12. SECURE WORK. Use clamps or a vise to hold the work when practical. It's safer than using your hand and it frees both hands to operate the tool.
 13. DON'T OVERREACH. Keep proper footing and balance at all times.
 14. MAINTAIN TOOLS WITH CARE. Keep tools sharp and clean for best and safest performance. Follow instructions for lubricating and changing accessories.
 15. DISCONNECT TOOLS before servicing and when changing accessories, such as blades, bits, cutters, and the like.
 16. REDUCE THE RISK OF UNINTENTIONAL STARTING. Make sure power switch is in the OFF position before plugging the machine in.
 17. USE RECOMMENDED ACCESSORIES. Consult the owner's manual for recommended accessories. The use of improper accessories may cause risk of injury to persons.
 18. NEVER STAND ON TOOL Serious injury could occur if the tool is tipped or if the cutting tool is unintentionally contacted.
 19. CHECK DAMAGED PARTS. Before further use of the tool, a guard or other part that is damaged should be carefully checked to determine that it will operate properly and perform its intended function - check for alignment of moving parts, binding of moving parts, breakage of parts, mounting, and any other conditions that may affect its operation. A guard or other part that is damaged should be properly repaired or replaced.

20. DIRECTION OF FEED. Feed work into a blade or cutter against the direction of rotation of the blade or cutter only.
21. NEVER LEAVE TOOL RUNNING UNATTENDED. TURN POWER OFF. Don't leave tool until it comes to a complete stop.

Règles de sécurité

"**AVERTISSEMENT**" : Pour votre sécurité, lire le manuel d'instruction avant d'utiliser le tour à bois.

- a) Portez des lunettes de protection
 - b) Ne pas porter de gants, de cravate, ou de vêtements amples.
 - c) Serrer tous les verrous avant d'opérer la machine.
 - d) Tourner la pièce à la main avant d'appliquer le courant.
 - e) Débiter grossièrement la pièce avant de l'installer sur le plateau de montage.
 - f) Ne pas monter une pièce fendue ou comportant un noeud.
 - g) Utiliser la vitesse la plus lente au démarrage d'une nouvelle pièce.
1. CONSERVEZ TOUS LES DISPOSITIFS DE PROTECTION EN PLACE et en bon état de fonctionnement.
 2. ENLEVEZ LES CLÉS ET OUTILS. Prenez l'habitude de vérifier si les clés et autres outils ne sont pas trop près de la machine avant de la démarrer.
 3. CONSERVEZ LA SURFACE DE TRAVAIL PROPRE ET LIBRE D'ENTRAVES. Les endroits encombrés augmentent le risque d'accident.
 4. NE PAS UTILISER DANS LES ENVIRONNEMENTS DANGEREUX. N'utilisez pas d'outils électriques dans les endroits humides, détrempés, ou sous la pluie. Conservez l'espace de travail bien éclairé.
 5. TENEZ LES ENFANTS À L'ÉCART. Tous les visiteurs doivent être tenus à une distance sécuritaire de l'aire de travail.
 6. RENDEZ L'ATELIER À L'ÉPREUVE DES ENFANTS avec des verrous, des interrupteurs principaux ou en enlevant les clés de démarrage sur les
 7. NE FORCEZ PAS L'OUTIL. L'outil effectuera un meilleur travail et de façon sécuritaire s'il est utilisé au rythme pour lequel il a été conçu.
 8. UTILISEZ L'OUTIL APPROPRIÉ. Ne forcez pas un outil ou un accessoire pour effectuer un travail pour lequel il n'a pas été conçu.
 9. UTILISEZ UNE RALLONGE ÉLECTRIQUE APPROPRIÉE. Assurez-vous que votre rallonge électrique est en bon état et que le calibre du filage soit adéquat pour transporter le courant que la machine a besoin. Une rallonge de trop faible calibre induira une perte d'intensité du voltage, ce qui provoquera une surchauffe et une perte de puissance. Le tableau A indique le bon calibre à utiliser en fonction de la longueur de la rallonge et de la demande en intensité du moteur. En cas de doute, utilisez la rallonge de calibre plus fort. Plus le numéro est petit, plus la rallonge est de fort calibre.
 10. PORTEZ DES VÊTEMENTS APPROPRIÉS. Ne portez pas de vêtements amples, des gants, des colliers, des bracelets, ou tout autre bijou ou accessoire qui pourrait être entraîné par des pièces mobiles. Des souliers à semelle antidérapante sont également recommandés. Coupez les cheveux longs et portez un bonnet pour contenir la chevelure trop abondante.
 11. PORTEZ DES LUNETTES DE PROTECTION. Portez également un masque contre la poussière si le travail exécuté dégage de la poussière. Veuillez prendre note que les lunettes de prescription ordinaire ne résistent pas aux impacts et qu'elles ne sont pas homologuées à des lunettes de sécurité.

12. **IMMOBILISEZ VOTRE TRAVAIL.** lisez des serres ou un étau pour immobiliser votre travail lorsque c'est possible. C'est plus sécuritaire que d'u liser votre main, et ça permet de libérer vos deux mains pour opérer l confortablement.
13. **NE VOUS ÉTIREZ PAS AU-DESSUS DE LA MACHINE.** Demeurez solidement en équilibre sur vos pieds en tout temps.
14. **ENTRETENEZ LES OUTILS AVEC SOIN.** Gardez les ls de coupe tranchants et propres pour en rer les meilleures performances. Suivez les ins du fabricant pour la lubrifica on et l'entr en des accessoires.
15. **DÉBRANCHEZ LES OUTILS** avant d'en effectuer l'entr en ou lors du changement d'accessoires tels que lames ou couteaux.
16. **RÉDUISEZ LES RISQUES DE DÉMARRAGE NON INTENTIONNEL.** Assurez-vous que l'interrupteur est en posi on fermée avant le branchement d'un ou l.
17. **UTILISEZ LES ACCESSOIRES RECOMMANDÉS.** Consultez le manuel d'instru pour connaître les accessoires recommandés. L'u lisa on d'accessoires inappropriés pose des risques de blessures aux liseurs.
18. **NE VOUS TENEZ JAMAIS DEBOUT SUR UNE MACHINE.** Des blessures graves pourraient survenir si la machine bascule ou si les ls coupants sont touchés accidentellement.
19. **VÉRIFIEZ LES PIÈCES ENDOMMAGÉES.** Avant de poursuivre l'u lisa on d'un l, tout disposi f de prot ou toute pièce endommagée devra être inspecté pour déterminer si elle peut fonc onner correctement et selon l'u lisa on qui en est prévue. Vérifiez l'alignement des pièces mobiles à savoir s'il y a blocage, un bris, ou toute autre co on qui nuirait à son lisa on. Une pièce ou un protecteur endommagé doit être réparé ou remplacé.
20. **SENS D'ALIMENTATION.** Alimentez la pièce vers la lame ou le couteau dans le sens contraire de sa rota on seulement.
21. **NE LAISSEZ JAMAIS UN OUTIL FONCTIONNER DANS SURVEILLANCE – ÉTEIGNEZ L'OUTIL.** Ne laissez pas l'ou l sans surveillance jusqu'à ce qu'il s'arrête complètement.

Locking the Lathe

It is strongly recommended that the lathe is never be left unattended in the unlocked condition.

To lock the machine it is recommended that a cover (not supplied) is made to lock the control panel. We have supplied two concepts for locking the panel (see below). The cover can be made from wood or plastic.

First, push down the emergency stop. Then lock the cover together by putting padlocks [not included] on the two handles on the control panel. To safeguard your machine from unauthorized operation and accidental starting by young children, the use of padlocks is strongly recommended.

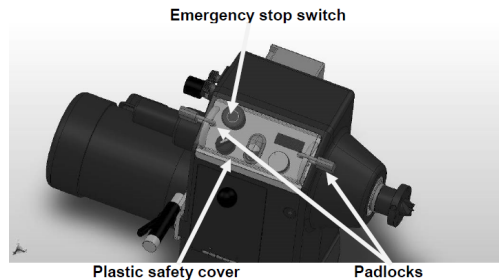
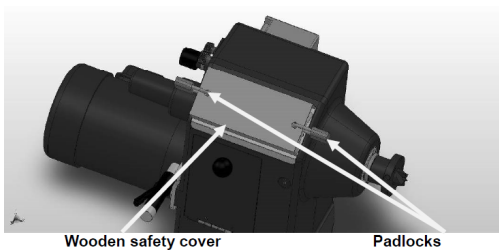

Proposition 65 Warning of Harmful Exposure

Some dust created by power sanding, sawing, grinding, drilling and other construction activities contains chemicals known to cause cancer, birth defects or other reproductive harm. Some examples of these chemicals are:

- Lead from lead-based paint.
- Crystalline silica from bricks, cement, and other masonry products.
- Arsenic and chromium from chemically treated lumber.

Your risk of exposure varies, depending on how often you do this type of work. To reduce your exposure to these chemicals, work in a well-ventilated area and work with approved safety equipment, such as face or dust masks that are specifically designed to filter out microscopic particles.

Notes Concerning Noise Emission

Given that there exists a relationship between noise level and exposure times, it is not possible to precisely determine the need for supplementary precautions. The factors affecting the true level of exposure to operators are clearly the amount of time exposed and the characteristics of the working environment, such as other sources of dust and noise, etc.,

for example, adjacent machines - in other words, the level of ambient noise. It is possible that exposure level limits will vary from country to country.

**SAVE THESE INSTRUCTIONS.
Refer to them often and use them to instruct others.**

Electrical Safety

Power Connections

A separate electrical circuit should be used for each machine. This circuit should not be less than the wiring listed below and should be protected with an appropriate circuit breaker based on the total running and start-up amperage's (listed below). If an extension cord is used, use only 3-wire extension cords which have 3-prong grounding type plugs and matching receptacle which will accept the machine's plug.

⚠ CAUTION! Running on a different voltage than stated below will damage the machine. Never run the machine in wet or damp conditions.

MLAREVO 1836-110-150	
VOLTAGE	115V
PHASE	1Ph
HERTZ	60Hz
FULL LOAD AMPERAGE	See Motor Plate
<p>⚠ WARNING! Below are RECOMMENDATIONS to be used for this machine based on the above information. Variables outside of our control are:</p> <ul style="list-style-type: none"> • Actual voltage supplied to the machine • Electrical code that must be met in your local province. <p>An electrician will verify that all the demands are met to properly wire the machine. If you have absolutely any doubt when wiring this machine - please consult with a qualified electrician.</p>	
PLUG/RECEPTACLE	5-15
WIRING (Gauge)	14 Ga.
CIRCUIT BREAKER	15A

MLAREVO 1836-220	
VOLTAGE	230V
PHASE	1PH
HERTZ	60Hz
FULL LOAD AMPERAGE	See Motor Plate
<p>⚠ WARNING! Below are RECOMMENDATIONS to be used for this machine based on the above information. Variables outside of our control are:</p> <ul style="list-style-type: none"> • Actual voltage supplied to the machine • Electrical code that must be met in your local province. <p>An electrician will verify that all the demands are met to properly wire the machine. If you have absolutely any doubt when wiring this machine - please consult with a qualified electrician.</p>	
PLUG/RECEPTACLE	6-15
WIRING (Gauge)	14 Ga.
CIRCUIT BREAKER	15A

If this information is different than what is stated on the Motor Specification Plate - omit this information. It is possible that the documentation is outdated to a machine change - such as a different motor. Always check the motor plate prior to any wiring. If any doubts, please consult a certified electrician.

Know when to use a time delay fuse! AKA Slow blow fuse. Generally, if the motor uses a start capacitor, a time delay fuse is required. This type of fuse (circuit breaker) will not trip with the initial amperage needed to start the machine, which is typically double that of the running amperage. Most woodworking machines use this type of fuse.

Grounding Methods

⚠ DANGER This machine must be grounded while in use to protect the operator from electric shock. In all cases, make certain that the receptacle in question is properly grounded. If you are not sure, have a qualified electrician check the receptacle.

Grounding Methods Provided by CSA Group. (A) Receptacle with nominal rating less than 150 volts. (B) 150 volt receptacle without grounding pin fitted with adapter. (C) 150-250 volt receptacle.

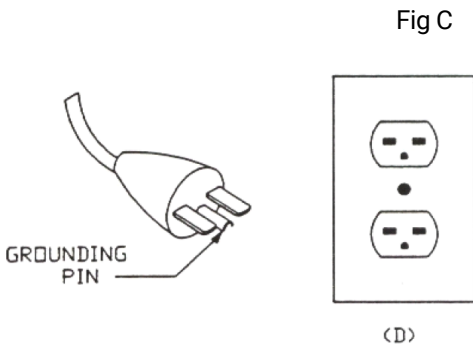
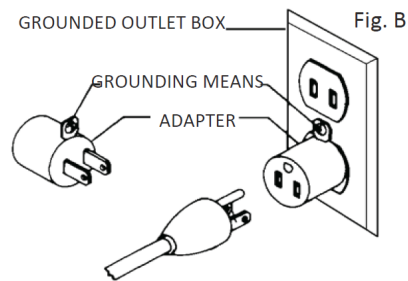
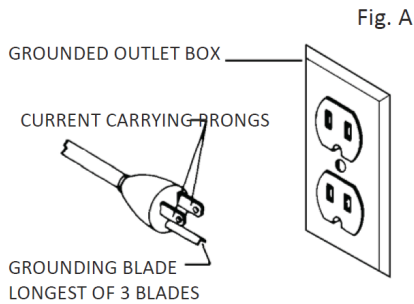

1. All grounded, cord-connected machines:

In the event of a malfunction or breakdown, grounding provides a path of least resistance for electric current to reduce the risk of electric shock. This tool is equipped with an electric cord having an equipment-

grounding conductor and a grounding plug. The plug must be plugged into a matching outlet that is properly installed and grounded in accordance with all local codes and ordinances.

Do not modify the plug provided - if it will not fit the outlet, have the proper outlet installed by a qualified electrician.

Improper connection of the equipment-grounding conductor can result in a risk of electric shock. The conductor with insulation having an outer surface that is green with or without yellow stripes is the equipment-grounding conductor. If repair or replacement of the electric cord or plug is necessary, do not connect the equipment-grounding conductor to a live terminal.

Check with a qualified electrician or service personnel if the grounding instructions are not completely understood, or if in doubt as to whether the tool is properly grounded.

Use only 3-wire extension cords that have 3-prong grounding plugs and 3 pole receptacles that accept the tool's plug.

Repair or replace damaged or worn cord immediately.

2. Grounded, cord-connected machines intended for use on a supply circuit having a nominal rating less than 150 volts:

This tool is intended for use on a circuit that has an outlet that looks like the one illustrated in Fig. A. The tool has a grounding plug that looks like the plug illustrated in Fig A. A temporary adapter, which looks like the adapter illustrated in Fig B may be used to connect this plug to a 2 pole receptacle as shown in Fig B if a properly grounded outlet is not available. The temporary adapter should be used only until a properly grounded outlet can be installed by a qualified electrician. This adapter is not permitted in Canada. The green-colored rigid ear, lug, and the like, extending from the adapter must be connected to a permanent ground such as a properly grounded outlet box.

3. Grounded, cord-connected tools intended for use on a supply circuit having a nominal rating between 150 – 250 volts, inclusive:

This tool is intended for use on a circuit that has an outlet that looks like the one illustrated in Fig C. The tool has a grounding plug that looks like the plug illustrated in Fig C. Make sure the tool is connected to an outlet having the same configuration as the plug. No adapter is available or should be used with this tool. If the tool must be reconnected for use on a different type of electric circuit, the reconnection should be made by qualified service personnel; and after reconnection, the tool should comply with all local codes and ordinances.

Extension Cords

⚠ WARNING! Use proper extension cords. Make sure your extension cord is in good condition and is a 3-wire extension cord which has a 3-prong grounding type plug and matching receptacle which will accept the machine’s plug. When using an extension cord, be sure to use one heavy enough to carry the current of the machine. An undersized cord will cause a drop in line voltage, resulting in loss of power and overheating. If in doubt, use the next heavier gauge. The smaller the gauge number, the heavier the cord.

MINIMUM GAUGE EXTENSION CORD 120V			
RECOMMENDED SIZES FOR USE WITH STATIONARY ELECTRIC MACHINES			
Ampere Rating	Volts	Total Length of Cord in Feet	Gauge of Extension Cord
0-6	120	up to 25	18 AWG
		25-50	16 AWG
		50-100	16 AWG
		100-150	14 AWG
6-10	120	up to 25	18 AWG
		25-50	16 AWG
		50-100	14 AWG
		100-150	12 AWG
10-12	120	up to 25	16 AWG
		25-50	16 AWG
		50-100	14 AWG
		100-150	12 AWG
12-16	120	up to 25	14 AWG
		25-50	12 AWG
		GREATER THAN 50 FEET NOT RECOMMENDED	

MINIMUM GAUGE EXTENSION CORD 240V			
RECOMMENDED SIZES FOR USE WITH STATIONARY ELECTRIC MACHINES			
Ampere Rating	Volts	Total Length of Cord in Feet	Gauge of Extension Cord
0-6	240	up to 50	18 AWG
		50-100	16 AWG
		100-200	16 AWG
		200-300	14 AWG
6-10	240	up to 50	18 AWG
		50-100	16 AWG
		100-200	14 AWG
		200-300	12 AWG
10-12	240	up to 50	16 AWG
		50-100	16 AWG
		100-200	14 AWG
		200-300	12 AWG
12-16	240	up to 50	14 AWG
		50-100	12 AWG
		GREATER THAN 100 FEET NOT RECOMMENDED	

Specifications

	MLAREVO 1836-220	MLAREVO 1836-110-150
Motor	Induction, 1725RPM, 2 HP 220V	Induction, 1725RPM, 1.5 HP 110V
Voltage	220v 60hz single phase input, 3 phase output	110v 60hz single phase input 3 phase output
Recommended breaker size	15 amp	15 amp
Swing over bed	18" (457mm)	18" (457mm)
Swing over banjo	13.5" (343mm)	13.5" (343mm)
Outboard swing max	32" (813mm)	32" (813mm)
Distance between centers	36" (914mm)	36" (914mm)
Floor to spindle center	41.5"(1054mm)	41.5"(1054mm)
Floor to bed height	32.5" with pads (826mm)	32.5" with pads (826mm)
Floor space	W60" D26" H47"(1524mm, 660mm, 1194mm)	W60" D26" H47"(1524mm, 660mm, 1194mm)
Tool rest	12" (305mm)	12" (305mm)
Speed range high	135 - 3500 RPM	135 - 3500 RPM
Speed range low	50 - 1300 RPM	50 - 1300 RPM
VFD	DeltaS1 variable frequency drive	DeltaS1 variable frequency drive
Drive belt	Poly-groove drive belt with easy access	Poly-groove drive belt with easy access
Spindle	1.25" x 8 tpi right hand thread	1.25" x 8 tpi right hand thread
Spindle taper	MT 2	MT 2
Spindle lock	Spring loaded	Spring loaded
Spindle index	14 / 36 / 48 positions with lock	14 / 36 / 48 positions with lock
Headstock & tailstock bore	0.375" dia (9.5mm dia)	0.375" dia (9.5mm dia)
Tail stock travel	4.5" (114mm)	4.5" (114mm)
Tail stock removal	Self- ejecting	Self- ejecting
Tailstock tapers	MT 2	MT 2
Face plate	3" diameter (76mm)	3" diameter (76mm)
Bed material	Steel	Steel
Weight (Net / ship)	427/452 lbs (194kg / 206 kg)	425/450 lbs(193/205 kg)

Machine Overview

Revo 18|36 Lathe

This machine is designed to give you years of safe service. Read this owner's manual in its entirety before assembly or use.

The lathe consists of a number of major parts, which are discussed in this manual. Take the time to read this section and become familiar with the machine.

Parts of the Lathe

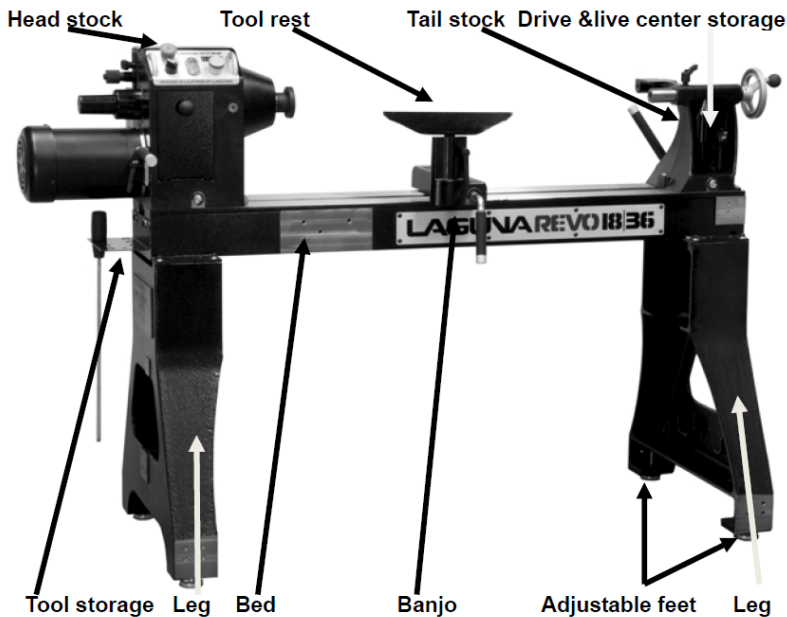

Identification Plaques

The identification plaques (name plate) is located on the reverse side of the bed.

Laguna REVO 18 36 Lathe	
Model	MLAREVO 1836
Motor	2HP, 230V
Power Requirements	230V 1Ph
Serial No.	
Taiwan TCP	

Laguna REVO 18 36 Lathe	
Model	MLAREVO 1836-110-150
Power Requirements	115V 1Ph
Serial No.	
Taiwan TCP	

Lathe Bed

The bed is a machined heavy steel welded construction.



Lathe Legs

The Legs are cast iron, and their heavy construction gives the machine a low center of gravity and ensures that it is very stable. The legs are supplied with adjustable feet to allow the machine to be leveled.



Head Stock

The head stock is cast iron and houses the variable speed control and motor. The Spindle can be locked in 14 / 36 and 48 positions.



Tail Stock

The tail stock is of cast iron construction, and the spindle has a travel of 4 1/2 in. It can accommodate centers and other tools which have a number 2 Morse Taper. The tail stock can be moved to any position on the lathe bed and locked to suit the job at hand.

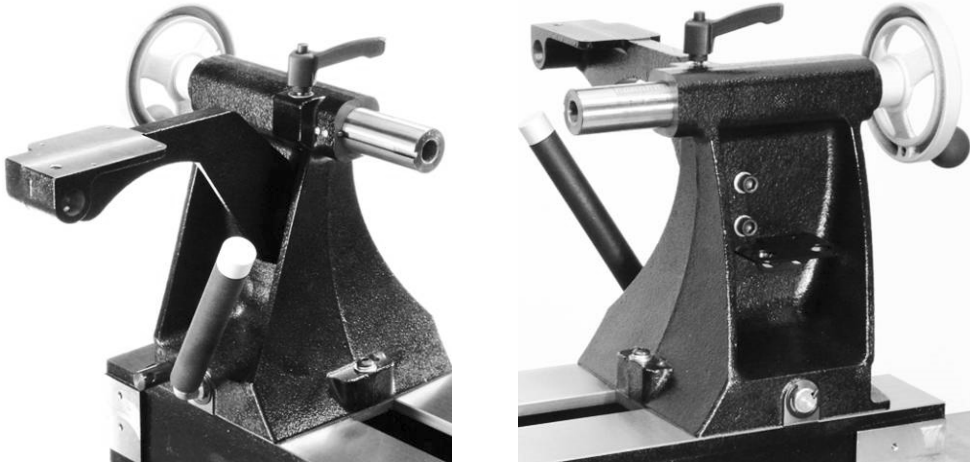

NOTICE! Lathes with machine serial number 20074159 and later will come with the new center to center adjustable function called "precise position" built into the tail stock. This allows fine adjustments to the spindle centers.

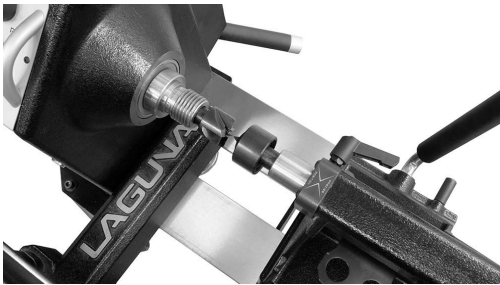

Tool Rest

The tool rest can be moved to any position on the lathe bed and locked to suit the job at hand. The tool rest has a tall profile to allow the bowl turner to turn steep angles. The leading edge is made from 6mm hardened steel.

Tool rest assembled to the bed



Tool rest



Electrical System

220V: The electrical control system (VFD) is housed at the back of the head stock, The VFD converts single phase 220v to three phase. There is a speed readout at the front of the lathe with controls to fine adjust the RPM of the spindle. . A power cord with 220V plug is provided.

110V: The electrical control system (VFD) is housed at the back of the head stock, The VFD converts single phase 110v to three phase. There is a speed readout at the front of the lathe with controls to fine adjust the RPM of the spindle. A power cord with 110V plug is provided.

VFD with cover open



Power cord



Tool Storage

A tool storage bracket which can be mounted on either leg.

Left of Bed Storage

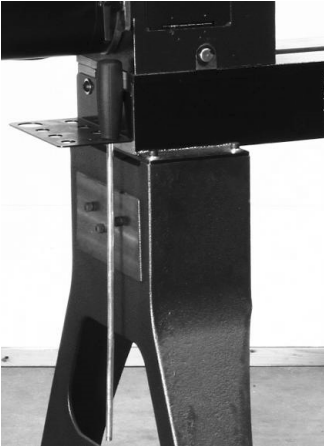

Lathe Controls

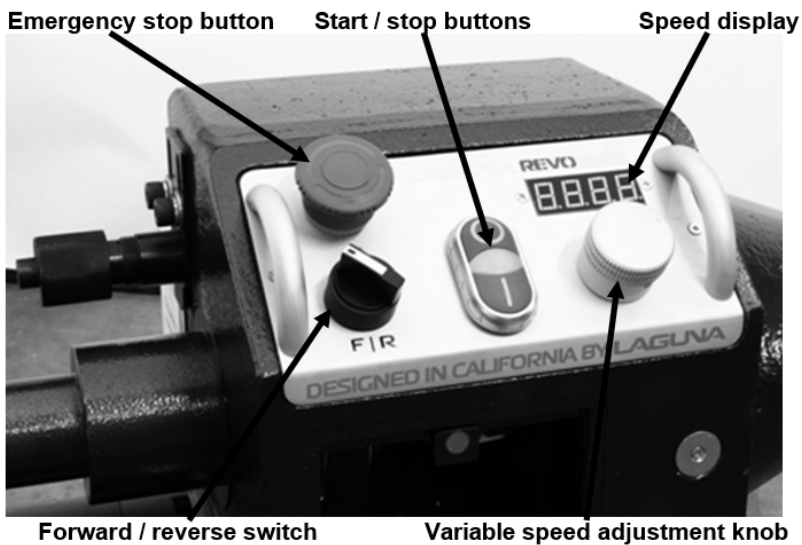

Emergency stop button

The emergency stop button will lock in the OFF position when fully depressed. To reset it, twist clockwise and it will pop out.

Forward / reverse switch.

The forward / reverse switch selects the direction of the rotation of the spindle.
The forward / reverse switch must only be used once the spindle has come to a complete stop.

Start / Stop buttons.

The start / stop buttons start the motor and the rotation of the spindle.

Speed display.

The speed display shows the RPM of the spindle.

Variable speed adjustment knob.

The Variable speed adjustment knob adjusts the spindle speed.

Turns clockwise to increase the speed, turns counter-clockwise to decrease the speed

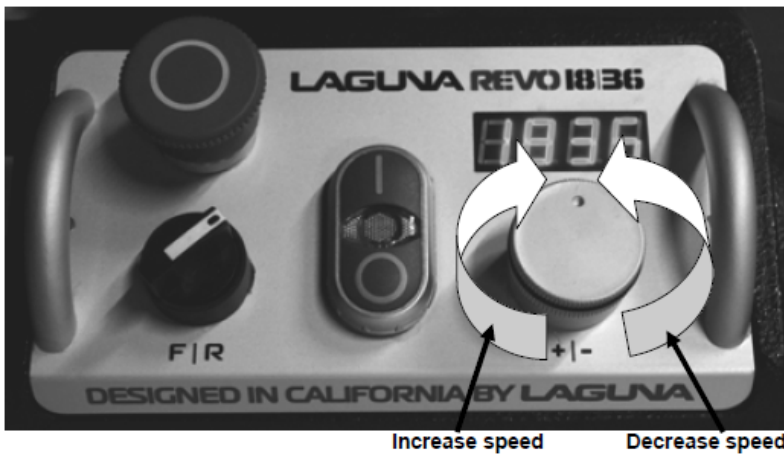

Setup

Setup Overview (MUST READ)

When setting up your Revo 18|36 Lathe, please take a moment to read this overview prior to starting.

The machine comes mostly assembled. You will have to assemble the legs, headstock, tailstock, tool storage and the tool rest to the bed of the machine. **NOTICE!** It is recommended that the head stock, tool rest and tailstock be removed from the bed of the lathe to ease assembly (Covered later in the manual).

After Setup, There may be a few adjustment to be made. All of these adjustments are done prior to shipping the machine, but if found to need adjustments please follow the adjustment guides.

⚠ CAUTION! If you have any doubt about the described procedure, seek professional assistance. Do not attempt any procedure that you feel is unsafe, or that you do not have the physical capability of achieving.

Videos

[REVO 1836 Lathe Setup - Unboxing The Lathe - Part 1](#)



[REVO 1836 Lathe Setup - 3 Inch Riser Blocks Install - Part 2](#)

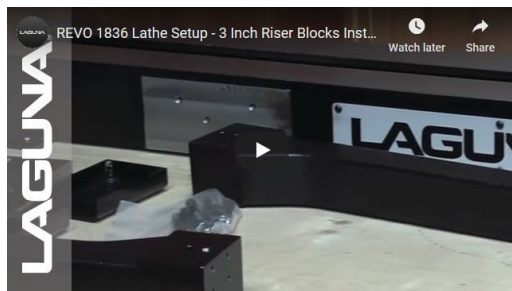

[REVO 1836 Lathe Setup - Mount Legs To Bed - Part 3](#)



[REVO 1836 Lathe Setup - Mount Head And Tailstocks - Part 4](#)



[REVO 1836 Lathe Setup - Install Standard Accessories - Part 5](#)



[REVO 1836 Lathe Setup - Mounting The Lights - Part 6](#)



[REVO 1836 Lathe Setup - Installing The Comparator - Part 7](#)



[REVO 1836 Lathe Setup - Install The Vacuum Inverter - Part 8](#)



[REVO 1836 Setup - Install 12 Inch Swingaway Extension - Part 9](#)



[REVO 1836 Lathe Setup - The 20 Inch Extension Riser Block - Part 10](#)



[REVO 1836 Lathe Setup - Dual Leg And Bed Assembly - Part 11](#)



[REVO 1836 Lathe Setup - 20 Inch Extension Front Mounted - Part 12](#)

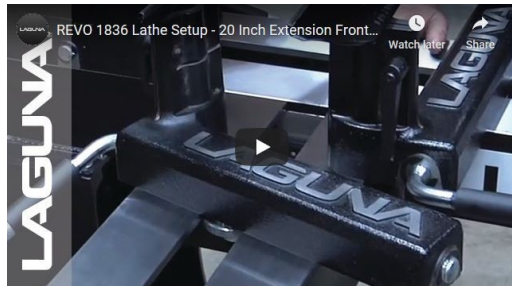

[REVO 1836 Lathe Setup - Deluxe Wheel System - Part 13](#)



[REVO 1836 Lathe Setup - Headstock Guard - Part 14](#)



[REVO 1836 Lathe Setup - Adjustments And Fine Tuning - Part 15](#)



Placement & Unboxing

Your Machine will likely be delivered by a third party delivery service. Before unpacking your new machine, first inspect the packaging, the invoice, and the shipping documents supplied by the driver. When unpacking your machine, separate all enclosed items from the packing materials and inspect them for damages. Ensure that there is no visible damage to either the packaging or the machine BEFORE the driver leaves. Save all packaging materials until you are satisfied with the machine and/or have resolved any issues concerning any missing or damaged items.

NOTICE! All shipping damage must be noted upon delivery and signed by the owner and the delivery driver. If you find any damaged items in your package, you must contact Laguna Tools to file a complaint. In order to return damaged goods under the limited warranty to Laguna Tools, Inc., you MUST have the original packaging. All claims of loss or damaged goods must be reported to Laguna Tools within 24 HOURS of delivery. Please contact the Laguna Tools, Inc. Customer Service Department to make claims for any damaged items/parts.

NOTICE! It is probable that you will find sawdust within your machine. This is because the machine has been tested prior to shipment from the factory and or Laguna Tools. We test machines prior to shipping to customers, but movement can take place during transportation. Some adjustments may have to be undertaken by the customer. These adjustments are covered in the various sections of this manual.

Placement

Before you remove your machine from the packaging, select the area where you will use your machine. There are no hard and fast rules for its location, but below are a few guidelines:

1. There should be sufficient area at the front of the machine to allow you to work on it comfortably.
2. There should be sufficient area at the back of the machine to allow access for adjustments and maintenance to be conducted.
3. Adequate lighting. The better the lighting the more accurately and safely you will be able to work.
4. Solid floor. You should select a solid flat floor, preferably one made of concrete or something similar.
5. Locate it close to a power source and dust collection.
6. Allow an area for the storage of blanks, finished products and tools.

Unboxing

Quick Reference Guide

<p>Add. Required Tools:</p> <ul style="list-style-type: none"> • Tin Snips • Box Cutter • Allen Wrench • Shop Rag • WD40 (Cleaning solvent)
<p>Troubleshooting/Tips:</p> <p>Cut the box, don't try to tug the bed out without a lift.</p>

NOTICE! The machine is heavy. Ensure that you have enough people to do the job safely. **NOTICE!** If you have any doubt about the described procedure, seek professional assistance. Do not attempt any procedure that you feel is unsafe, or that you do not have the physical capability of achieving.

1. Using the tin snips, cut the banding that is securing the packing box (If fitted). **⚠ WARNING! EXTREME CAUTION MUST BE USED, THE BANDING WILL SPRING AND COULD CAUSE INJURY.**

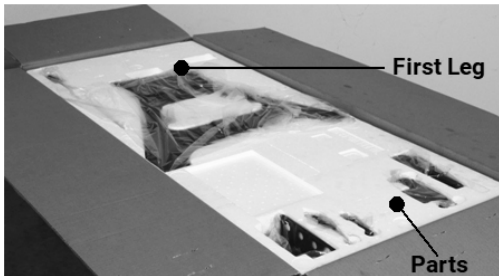

2. Open the box and remove the parts sent with the lathe including the first leg. **NOTICE!** The legs are heavy and caution must be exercised. They are cast iron and if dropped they will break.



3. Remove the top packaging and remove the second leg.



4. Cut all four corners with box cutter. Cut the styrofoam around the headstock and the tailstock



5. There is a stop at both ends of the bed. The stop is a safety feature that makes it impossible for the headstock or tailstock to slide off the end of the bed. Remove the stops to remove the headstock and tailstock. **NOTICE!** In order to get to the tailstock, you must break away the styrofoam packaging.

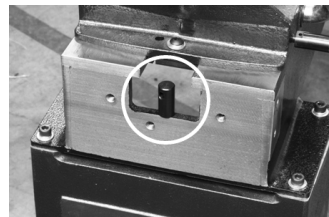

6. Remove the tailstock, headstock, and banjo. **NOTICE!** The headstock and tailstock can not be removed if they are locked to the bed. Disengage the lock handle prior to removal. **NOTICE! Even if you lifted the lathe out of the box with a lift, please remove everything from the bed.**











7. Clean the grease off all components with WD40, mineral spirits and a shop rag. Use caution with any thinners or de-greasers as it can damage the paint. Using water will result in rust as the lathe is raw metal.



Inventory List

The following depicts items shipped with your machine. Before assembling, ensure that you have received all parts shown below. Machine parts should arrive sealed in plastic bags. Remove parts from plastic bags before laying them out to inventory them.

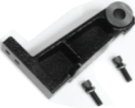



REF	Description	Q	PACKAGING
	Bed	1	Lower Packaging
	Headstock	1	Lower Packaging
	TailStock NOTICE! For lathes with serial number 20074159 and later include a new Precise Center Function on the tailstock.	1	Lower Packaging
	Banjo	1	Lower Packaging
	Legs	2	Upper Packaging / Lower Packaging
	Face Plate	1	Upper Packaging
	Tool Rack	1	Upper Packaging
	Rotating Center	1	Upper Packaging

REF	Description	Q	PACKAGING
	Drive Center	1	Upper Packaging
	Quill Knob	1	Upper Packaging
	Faceplate Wrench	1	Upper Packaging
	Knock Out Rod	1	Upper Packaging
	Adjustable Feet	4	Upper Packaging
	Tailstock Bracket & Hardware	1	Upper Packaging
	Headstock Bracket & Hardware	1	Upper Packaging
	Hardware	8	Upper Packaging
	Tool Rest	1	On Banjo

Assembling the Lathe

Quick Reference Guide

<p>Add. Required Tools:</p> <ul style="list-style-type: none"> • Allen Wrench • Hex Wrench
<p>Troubleshooting/Tips:</p> <p>The legs are not unique to the right or left side. If you purchased the riser blocks, install them now.</p>

Installing the legs to the bed

Parts Needed			
REF	Description	Q	Installation Location
	Bed	1	
	Legs	2	Bed
	Adjustable Feet	4	Legs
	Hardware	8	Legs to Bed

Method 1: Installing legs up, and then flipping.

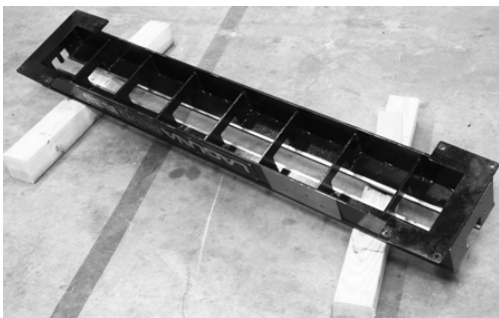
1. Fit the 4 leveling feet to the lathe legs with the lock nut on the underside of the leg.
2. Lay the bed on 2" X 4" timbers in the upside down position.



- Lift the legs to the vertical position and lower them onto the bed. Secure with the 8 fixing screws provided.

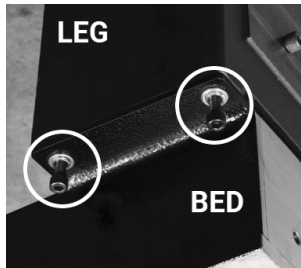

- Very carefully flip the lathe to the upright position. **⚠ CAUTION!** Do not slam the legs onto concrete - the cast iron will crack. **⚠ CAUTION!** At least two people will be needed to perform this step.



- Fine tune the leveling feet so the lathe bed is level.

Method 2: Using a Table

- Install the Leveling feet to the legs.
- Place the bed on the table.
- With the Bed on a table, position one leg under and proceed to fasten the bolts - as pictured below.







- Using two persons, have one person position the second leg, and the other person push the bed in place. **⚠ CAUTION!** USE CATION, WATCH YOUR FINGERS. **⚠ CAUTION!** At least two people will be needed to perform this step.



5. Carefully move the lathe away from the table.
6. Fine tune the leveling feet so the lathe bed is level.

Tailstock, Headstock, Banjo

Parts Needed			
REF	Description	Q	Installation Location
	Headstock	1	Bed
	TailStock NOTICE! For lathes with serial number 20074159 and later include a new Precise Center Function on the tailstock.	1	Bed
	Quill Knob	1	Tailstock
	Banjo	1	Bed

Cleaning the clamps is important to proper use

Prior to installation, take a moment to clean off the grease on all locking mechanisms with WD40 or mineral spirits. The areas of concern are pictured below.

Underside of bed

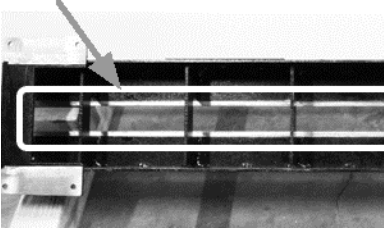

Banjo Post hole & Tool Rest post



Cam Lock Washer, Headstock, Tailstock, Banjo



NOTICE! If it is discovered that the tool rest post does not stay in place when using, it is because of a lubricant within the clamp (banjo post hole and tool rest post). To remedy this, clean off any grease or oil with a shop rag. An anti slip friction paste can be used to further hold the post.

The Tailstock, Headstock and Banjo all use the same cam locking mechanism. The nut underneath the mechanism should be adjusted such that the clamp handle locks with approximately 30 degree of movement.

Un-assembled



Washer fitted underneath bed

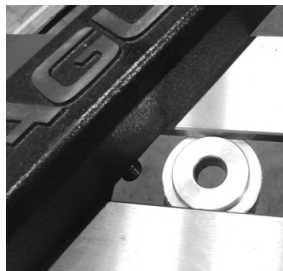

Nut



Clamp Handle



1. Install the Tailstock to the bed, then install the quill knob to the tailstock.



2. Install the Banjo to the bed.



3. Install the Headstock. **⚠ CAUTION!** At least two people will be needed to perform this step.



4. Re-install the Stops to prevent the headstock and tailstock from coming off the bed.



The 1836 Lathe is now assembled.



When giving power to your machine ensure that the electrical supply corresponds with that of the machine (Single phase 220V or 110V). See the [Electrical Safety](#) ¹⁰ section for all electrical information. It is recommended that you use a 15-amp main breaker. Note. A qualified electrician must carry out the installation.

⚠ CAUTION! Running on a different voltage than listed on the machine plaque of your machine will damage it and could cause personal injury.

Standard Accessories

Quick Reference Guide

<p>Add. Required Tools:</p> <ul style="list-style-type: none"> • Included wrenches • Allen Wrench
<p>Troubleshooting/Tips:</p> <p>Go through each installation and remove to familiarize proper procedure.</p>

Installing the Faceplate

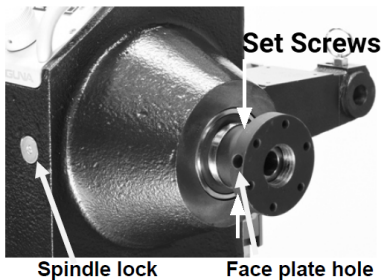

Parts Needed			
REF	Description	Q	Installation Location
	Face Plate	1	Upper Packaging
	Faceplate Wrench	1	Upper Packaging

- There are two set screws on the faceplate.
- Lock the spindle and screw in the faceplate.
- Fasten down the two set screws.

To remove the face plate from the head stock spindle, loosen the set screws and remove the faceplate with the faceplate wrench.



Installing the Driver (Spur) Center

Parts Needed			
REF	Description	Q	Installation Location
	Drive Center	1	Headstock
	Knock Out Rod	1	Upper Packaging

- Ensure that the bore of the head stock is clean. The drive center has a number No. 2 Morse Taper that fits into the head stock.
- Push the center into the head stock bore firmly, and ensure that it is securely located.
- To remove the center, push the removal shaft into the back of the head stock, and give it a sharp knock. This will remove the drive center.

⚠ WARNING! Never leave the removal shaft in the head stock with the machine running.

Installation

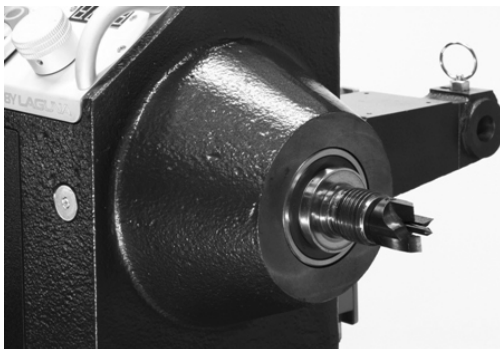

Removal



Installing the Live (Rotating) Center



Parts Needed			
REF	Description	Q	Installation Location
	Rotating Center	1	Tailstock

- Ensure that the bore of the tail stock is clean. The rotating center has a number 2 Morse Taper that fits into the tail stock.
- Push the center into the tail stock bore firmly, and ensure that it is securely located.
- To remove the center, rotate the adjusting handle until it is as far back as possible and this will eject the center.

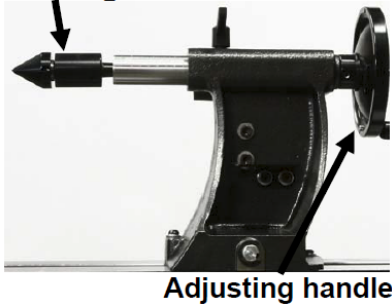
Rotating center



Installing the Headstock & Tailstock Bracket

Parts Needed			
REF	Description	Q	Installation Location
	Headstock Bracket & Hardware	1	Headstock
	Tailstock Bracket & Hardware	1	Tailstock

The brackets are used to mount several accessories offered for the Revo line.

Headstock Bracket



Tailstock Bracket



Both Brackets Installed



Installing the tool rack

Parts Needed			
REF	Description	Q	Installation Location
	Tool Rack	1	Leg

The Tools rack can be installed on any of the mounting locations, and in the upside down position (higher) **NOTICE!** If installing in the front position, the banjo lock may interfere. The intended location shown below has no interference.

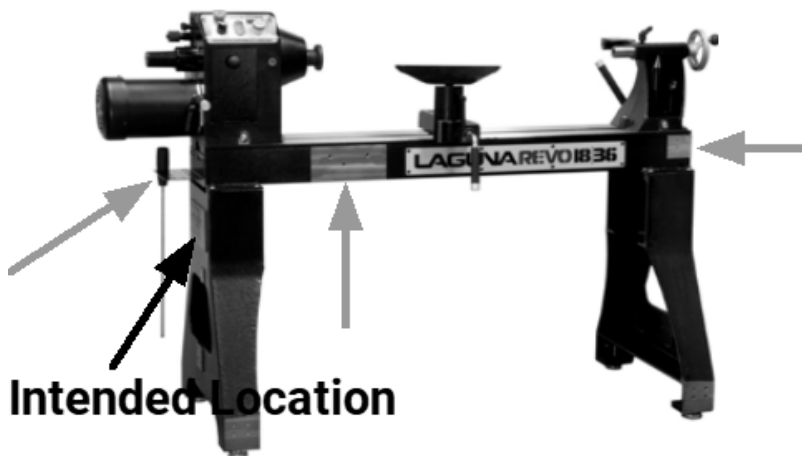

Adjustments

The machine is shipped perfectly adjusted. However during transit, some adjustments could be tweaked. If one is found, follow these guides to resolve.

⚠ CAUTION! If you have any doubt about the described procedure, seek professional assistance. Do not attempt any procedure that you feel is unsafe, or that you do not have the physical capability of achieving.

High / Low Speed Belt Change

Speed Range Cabinet

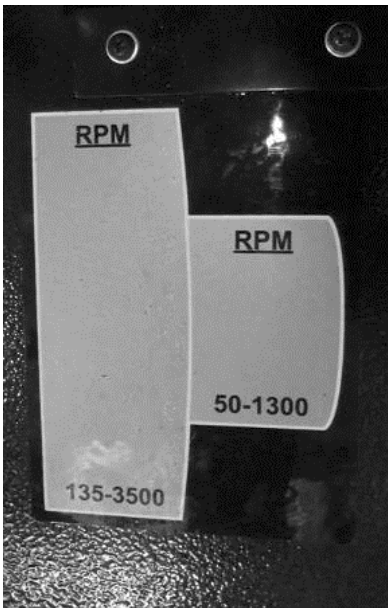

DANGER

Make sure the machine is unplugged with no chance of turning on when performing this procedure.

The lathe has two sets of pulleys for high (135 - 3500 RPM) and low (50 - 1300 RPM) speed ranges.

Adjust between the speed ranges as follows.

1. Disconnect the electric supply to the lathe.
2. Open the pulley cover.
3. Loosen the motor lock handle and lift the motor to the highest position with the motor adjustment handle, then lock the motor lock handle.
4. Move the drive belt to the required set of pulleys.
5. Loosen the motor lock handle and with the motor adjustment handle tension the drive belt, then lock the motor lock handle.

The belt should be tensioned so that there is approximately 1/8 to 1/4 " deflection when the belt is pressed with moderate thump pressure.

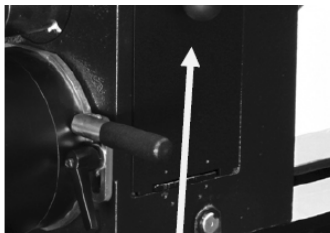

Pulley cover

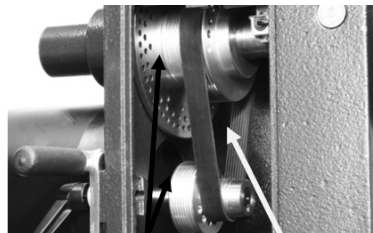

Pulleys and drive belt

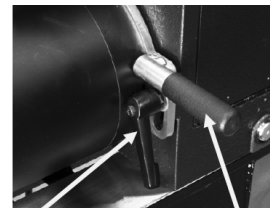

Motor lock handle Motor adjustment handle

Indexing the Spindle

Indexing System

Clamping knobs

Hole selection indicator

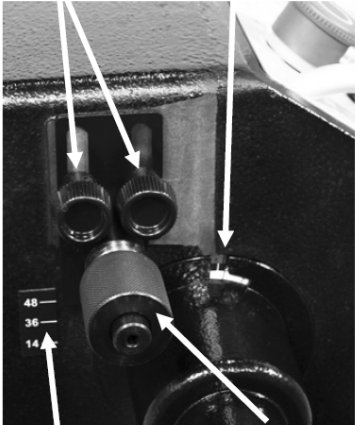

Hole selection

Indexing plunger



WARNING

Do not turn the machine on with the indexing or spindle lock engaged.

Indexing is a method of splitting 360 degrees into X parts. It is very useful to have for forming spirals, channels, or notches on a work piece.

- The spindle has 3 sets of indexing holes 14 / 36 / 48.
- The selection plunger is located at the end of the head stock.
- To move between the 3 sets of holes, loosen the clamp knobs and slide the indexing plunger assembly to align with the selected hole set.
- Clamp in position with the clamp knobs.
- Try the plunger in a few different holes to check that it inserts and removes smoothly.
- The indexing plunger is spring loaded and this is used only to temporarily align the plunger in the selected hole.
- To fix the plunger in a selected hole, it must be attached to the housing by screwing into the clamped position.
- There is a hole selection indicator that allows you to view which hole in a selected hole set has been selected.

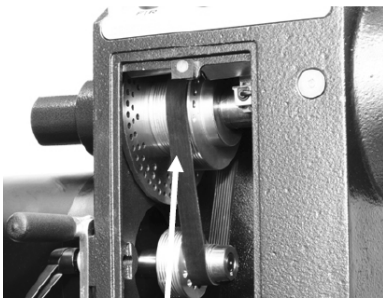

Indexing holes

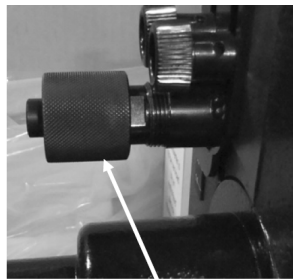

Indexing plunger disengaged

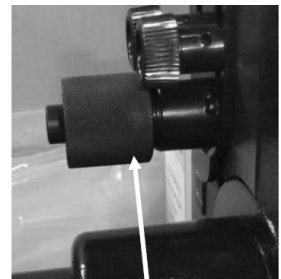

Indexing plunger engaged

Side to Side Stock Adjustments

Tail Stock

Adjustment slot



View under the tailstock

Loosen the clamp handle on the tailstock and check for side movement. If it is excessive, Insert an Allen key into the adjusting screw and tighten.

NOTICE! By rotating the adjustment screw, it moves into the adjusting slot which opens and removes the excessive clearance between the tailstock and the bed.

NOTICE! Only make very small adjustments and then recheck the clearance. After adjustment

The tailstock should be slid along the bed to check for any area that it binds in the bed slot. The same procedure as above should be conducted on the head stock should it be required.

NOTICE! It is very unlikely that the headstock will require adjustment as it is not moved as often as the tailstock, so has less tendency's for ware.

NOTICE! Adjoining the side clearance will change the center to center alignment, please do both procedures.

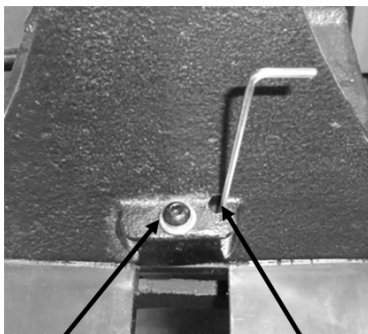

Clamp screw

Adjusting screw

Adjustment slot



View under headstock

Center to Center Adjustment

Center Points Aligned

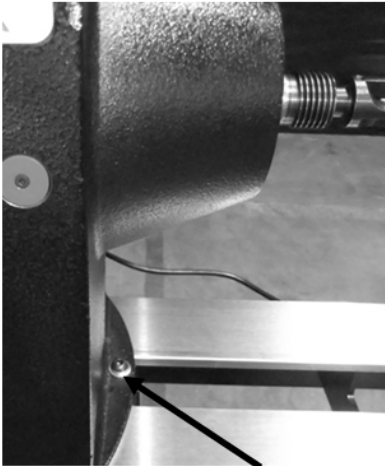

Headstock clamp screw

NOTICE! For Lathes with machine serial number 20074159 and later, or newer, please use the precise position adjustment to further dial in center to center alignment.

NOTICE! The slide clearance of the headstock and the tailstock must be checked and adjusted should it be needed prior to adjusting the center point alignment.

The center point alignment is adjusted at the factory and no adjustment should be required. Should movement or wear have taken place, the following adjustment procedure should be conducted.

The tailstock has two clamp screws that are accessible from the top of the tailstock. The clamp screws hold the slide plate to the tailstock casting. There is clearance in the holes that allows the tailstock to be moved in relation to the slide plate. The headstock also has two clamp screws, but one is accessible from under the headstock.

By loosening the clamp screws the headstock and tailstock can be moved and the center points aligned.

NOTICE! It is recommended that the head stock be adjusted and not the tail stock. If the tail stock is not adjusted parallel to the bed slide, the center point will not be in alignment when the spindle is extended or retracted.

1. Loosen the clamp screw that is accessible from the top on the head stock.
2. Tap the side of the headstock with a rubber mallet close to the base in the direction requiring adjustment and re-tighten the clamp screw.
3. Recheck the center point alignment and repeat if required.
- 4.

⚠ CAUTION! Never hit any part of the lathe that is cast iron with a metal hammer or similar as it will break the casting.

For Lathes With Precise Position



Year 2020 and new 1836 lathes are equipped with a precise position function that allows you to ensure center to center contact between the spindle and quill.

The adjustment is simple.

1. Loosen the four Allen screws by a 1/8" hex wrench.
2. Lock down the tailstock.
3. Lock quill
4. Adjust center to center alignment
5. Fasten the four Allen screws.

Maintenance

General

Keep your machine clean. At the end of each day, clean the machine. Wood contains moisture, and if sawdust or wood chips are not removed they will cause rust.

In general, we recommend that you only use a Teflon-based lubricant on the lathe. Regular oil attracts dust and dirt. Teflon lubricant tends to dry and has less of a tendency to accumulate dirt and saw dust.

Periodically check that all nuts and bolts are tight.

Drive Belt

The drive belt should last for many years (depending on the usage) but needs to be inspected regularly for cracks, cuts and general wear. If damage is found, replace the belt.

Bearings

All bearings are sealed for life and do not require any maintenance. If a bearing becomes faulty, replace it.

Rust

The lathe is made from steel and cast iron. All none-painted surfaces will rust if not protected. It is recommended that they be protected by applying wax or a Teflon- based lubricant to them.

Center Point Alignment & Side Clearance Adjustment

The center point alignment and slide clearance are adjusted at the factory and no adjustment should be required.

Should movement or wear have taken place, the following adjustment procedure should be conducted.

Note. The slide clearance of the headstock and the tailstock must be checked and adjusted should it be needed prior to adjusting the center point alignment.

Troubleshooting

Lathe will not start.

1. Check that the start switch is in the correct position.
2. Check that the electrical power cord is plugged into the power outlet.
3. Check that the electrical supply is on (reset the breaker).
4. With the power disconnected from the machine, check that the wiring to the plug is correct. Check that the rubber insulation is stripped enough and is not causing a bad connection. Check that all the screws are tight.
5. Emergency stop button engaged. Reset emergency stop button. Twist and it will pop out.

The machine will not stop.

This is a very rare occurrence as the machine is designed to be fail-safe. If it should occur and you cannot fix the fault, seek professional assistance. The machine must be disconnected from the power and never run until the fault has been rectified. The only cause of this is a faulty stop switch.

Motor tries to start but will not turn.

1. With the power disconnected from the machine, try to turn the spindle by hand. If the spindle will not turn, check the reason for jamming.
2. Motor faulty. Replace the motor.
3. Power line overloaded. Correct overloaded condition.
4. Low voltage. Correct low voltage condition.

Motor overheats.

The motor is designed to run hot, but should it overheat it has an internal thermal overload protector that will shut it down until the motor has cooled, and then it will reset automatically. If the motor overheats, wait until it has cooled and restart. If the motor shuts down consistently check for the reason. Typical reasons are dull cutting tools, the motor cooling fan being clogged or faulty, the motor cooling fins are clogged, overfeeding the job, and excessive ambient temperature.

Squeaking noise.

1. Check that the motor cooling fan is not contacting the fan cover.
2. Check the bearings.
3. Check the drive belt is tensioned correctly.

Spindle slows down during a cut.

1. Dull cutting tools. Replace the tool or have it re-sharpened.
2. Feeding the wood too fast. Slow down the feed rate.
3. Oil or dirt on the drive belt. Clean or replace the drive belt.
4. Drive belt loose. Re-tension drive belt.

Machine vibrates.

1. Machine not level on the floor. Re-level the machine ensuring that it has no movement.
2. Damaged drive belt. Replace the belt.
3. Job is not balanced. Change to slower speed and/ or balance the job.
4. Damaged pulley. Replace the pulley.
5. Worn spindle bearing. Replace the bearing.

Wiring



WARNING

Review [Electrical Safety](#) prior to any wiring procedures.

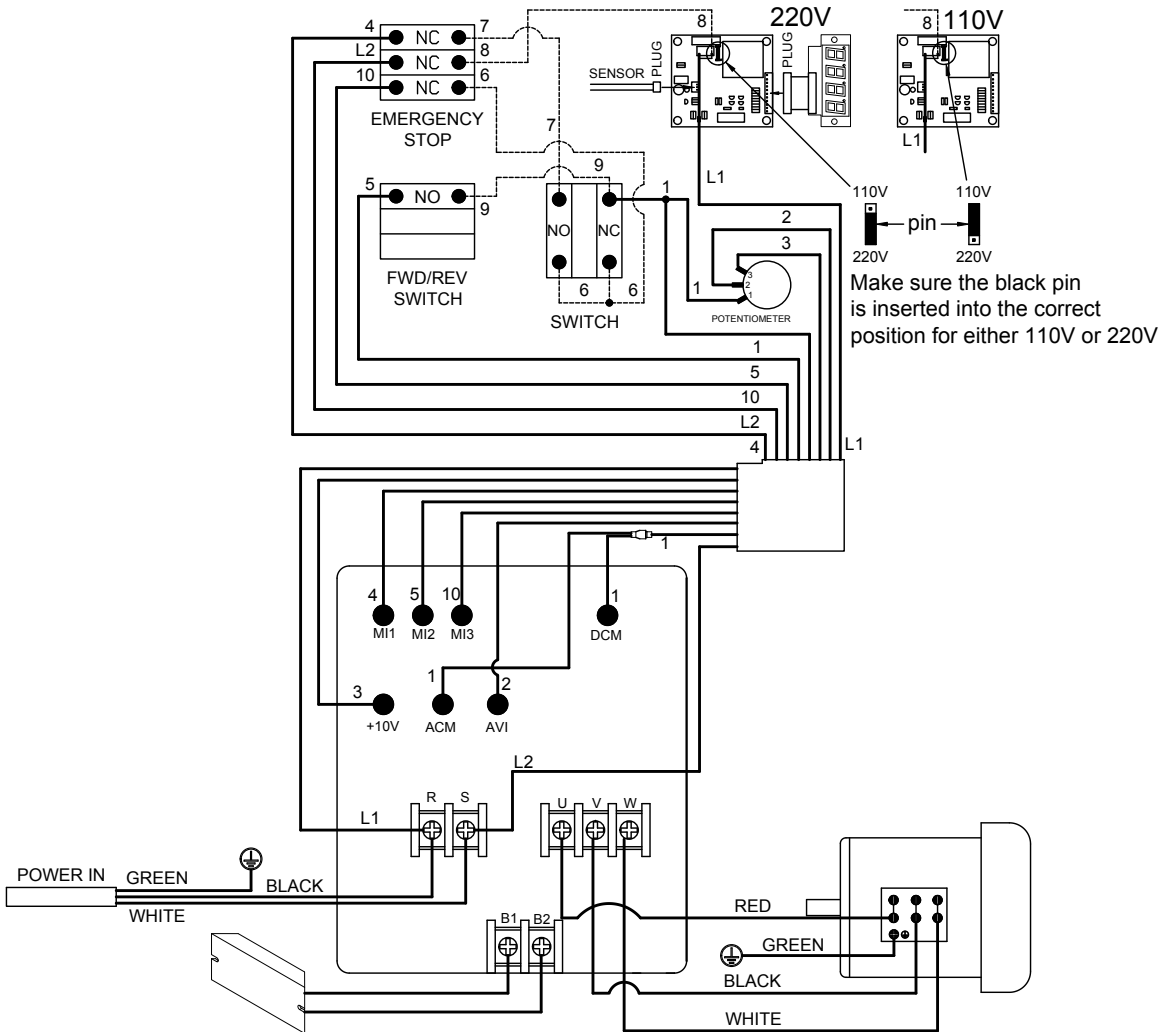

Replacement Parts Diagram

Bed, Headstock, Drive Center

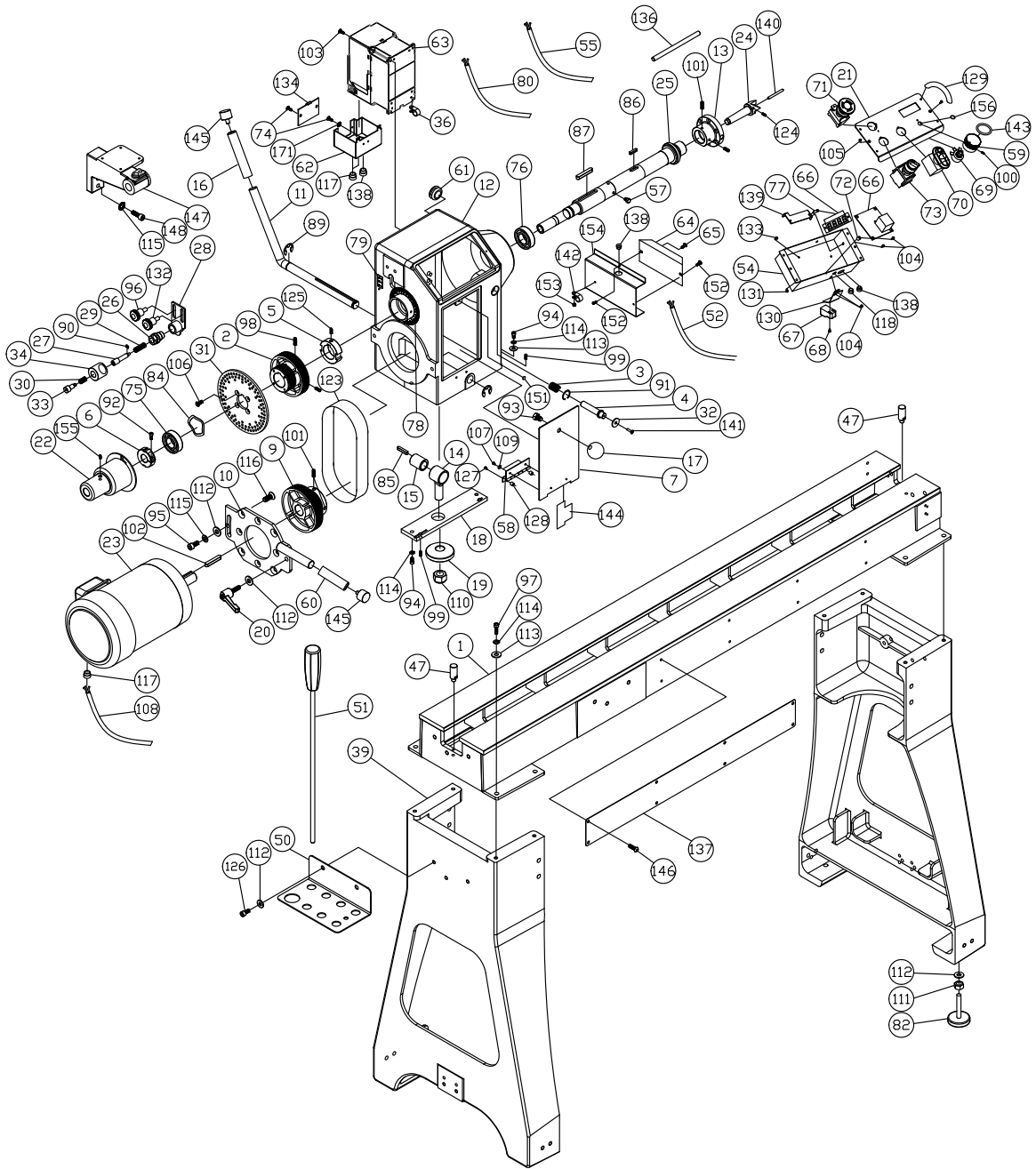

Bed, Banjo, Tail Stock, Live Center

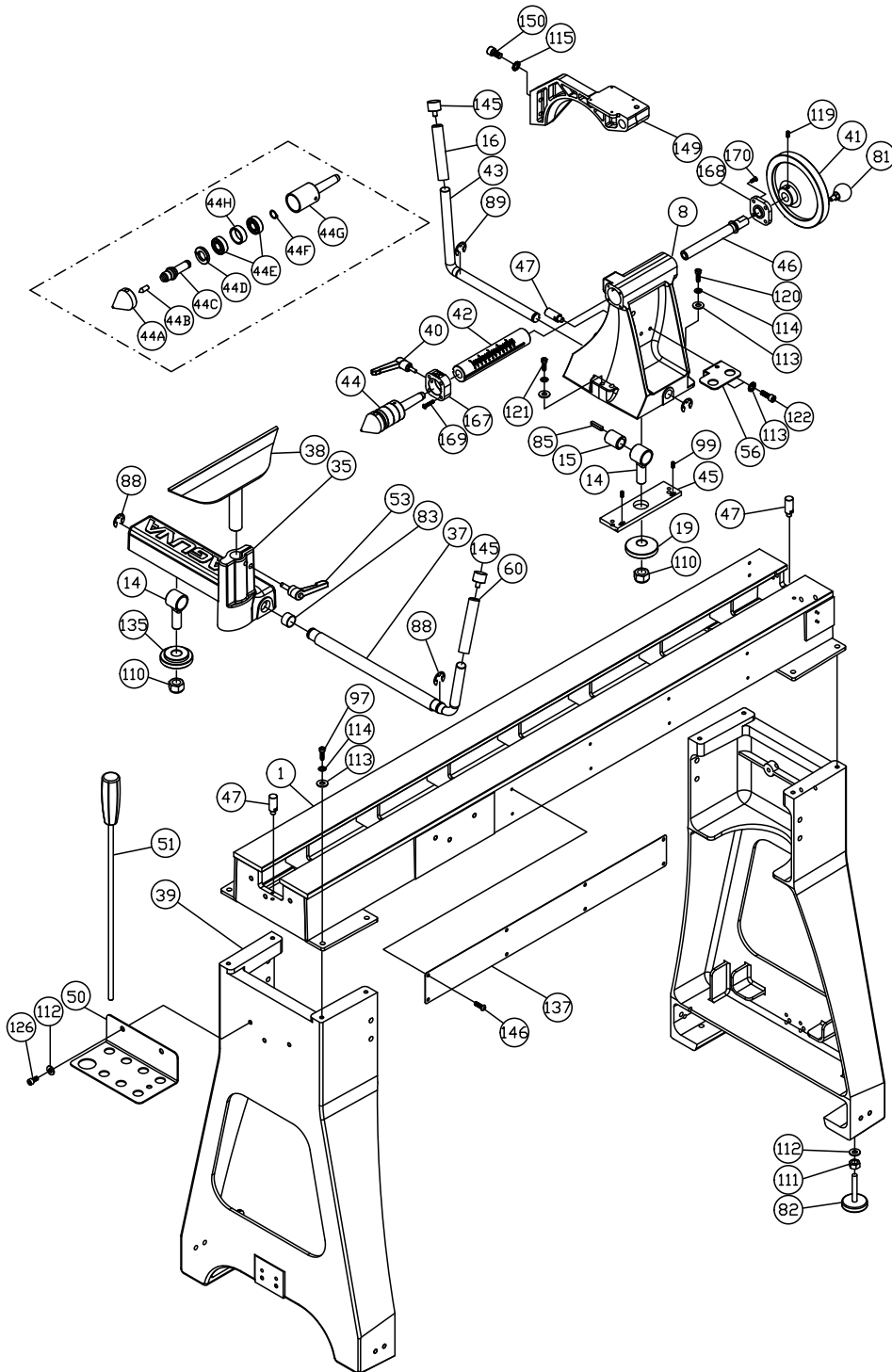

Replacement Parts Table

Index	Part Number	Item Description	Specification	Qty
1	PLAREVO1836-101	Bed		1
2	PLAREVO1836-102	Spindle Pulley		1
3	PLAREVO1836-103	Spring		1
4	PLAREVO1836-104	Spindle Lock Plunger		1
5	PLAREVO1836-105	Locking Collar		1
6	PLAREVO1836-106	Bearing Nut		1
7	PLAREVO1836-107	Door		1
8	PLAREVO1836-108A	Tailstock		1
9	PLAREVO1836-109	Motor Pulley		1
10	PLAREVO1836-110	Motor Plate		1
11	PLAREVO1836-111	Headstock Locking Handle		1
12	PLAREVO1836-112A	Headstock		1
13	PLAREVO1836-113	3" Faceplate		1
14	PLAREVO1836-114	Clamp Bolt		3
15	PLAREVO1836-115	Sleeve		2
16	PLAREVO1836-116	Rubber Sleeve		2
17	PLAREVO1836-117	Knob		1
18	PLAREVO1836-118	Headstock Adjusting Plate		1
19	PLAREVO1836-119	Clamp		2
20	PLAREVO1836-120	Lock Handle		1
21	PLAREVO1836-121	Control Panel		1
22	PLAREVO1836-122	Handwheel		1
23	PLAREVO1836-123	Motor 2HP		1
	PLAREVO1836-110-150-123	Motor 1.5HP		1
24	PLAREVO1836-124	Spur Center		1
25	PLAREVO1836-125	Spindle		1
26	PLAREVO1836-126	Index Stud		1
27	PLAREVO1836-127	Index Shaft		1
28	PLAREVO1836-128	Index Bracket		1
29	PLAREVO1836-129	Spring		1
30	PLAREVO1836-130	Spring		1
31	PLAREVO1836-131	Index Plate		1
32	PLAREVO1836-132	Disc, Spindle Lock		1

Index	Part Number	Item Description	Specification	Qty
33	PLAREVO1836-133	Index Bolt		1
34	PLAREVO1836-134	Index Knob		1
35	PLAREVO1836-135	Tool Rest Support Base		1
36	PLAREVO1836-136	Cord Holder		1
37	PLAREVO1836-137	Tool Rest Locking Handle		1
38	PLAREVO1836-138	12" Tool Rest		1
39	PLAREVO1836-139	Leg		2
40	PLAREVO1836-140A	Lock Handle		1
41	PLAREVO1836-141	Handwheel		1
42	PLAREVO1836-142A	Quill		1
43	PLAREVO1836-143	Tailstock Locking Handle		1
44	PLAREVO1836-144	Live Center Assembly		1
45	PLAREVO1836-145	Tailstock Adjusting Plate		1
46	PLAREVO1836-146	Lead Screw		1
47	PLAREVO1836-147	Stop Bolt		3
50	PLAREVO1836-150	Tool Caddy		1
51	PLAREVO1836-151	Knockout Rod		1
52	PLAREVO1836-152	Braking Resistor Cord		1
53	PLAREVO1836-153	Lock Handle		1
54	PLAREVO1836-154	Control Box		1
55	PLAREVO1836-155A-UK	Control Cord		1
56	PLAREVO1836-156	Tailstock Tool Caddy		1
57	PLAREVO1836-157	Hex Cap Screw	M6x6	4
58	PLAREVO1836-158	Door Hinge		1
59	PLAREVO1836-159	Speed Knob		1
60	PLAREVO1836-160	Rubber Sleeve		2
61	PLAREVO1836-161	Rubber Bushing		1
62	480BS-148C	Bottom Cover		1
63	PLAREVO1836-163-ME	Inverter 220V		1
	PLAREVO1836-110-150-163-ME	Inverter 110V		1
64	PLAREVO1836-164	Braking Resistor		1
65	PLAREVO1836-165	Screw	M4x12	1
66	PLAREVO1836-166	Digital Readout		1
67	PLAREVO1836-167	Digital Readout Sensor		1
68	PLAREVO1836-168	Screw	M3x20	2
69	PLAREVO1836-169	Control Pot Assembly		1

Index	Part Number	Item Description	Specification	Qty
70	PLAREVO1836-170	ON/ OFF Switch		1
71	PLAREVO1836-171A	Emergency Stop		1
72	PLAREVO1836-172	Spacer		2
73	PLAREVO1836-173A	Fwd/Rev Switch		1
74	480BS-117	Screw	M4x6	4
75	PLAREVO1836-175	Ball Bearing	6205LLU	1
76	PLAREVO1836-176	Ball Bearing	6207LLU	1
77	PLAREVO1836-177	Pillar		2
78	PLAREVO1836-178	Index Label		1
79	PLAREVO1836-179	Index Indicator		1
80	PLAREVO1836-180	Power Cord 220V		1
	PLAREVO1836-110-150-180	Power Cord 110V		1
81	PLAREVO1836-181	Knob		1
82	PLAREVO1836-182	Leveling Foot		4
83	PLAREVO1836-183	Bushing		1
84	PLAREVO1836-184	Wave Washer	6205	1
85	PLAREVO1836-185	Key	6x6x30	2
86	PLAREVO1836-186	Key	8x7x25	1
87	PLAREVO1836-187	Key	8x7x60	1
88	PLAREVO1836-188	E-Ring	E19	2
89	PLAREVO1836-189	E-Ring	E15	4
90	PLAREVO1836-190	E-Ring	E5	1
91	PLAREVO1836-191	C-Ring	R22	1
92	PLAREVO1836-192	Socket Head Cap Screw	1/4-20UNCx1"	1
93	PLAREVO1836-193	Hex Cap Screw	3/8-16UNCx1/2"	1
94	PLAREVO1836-194	Socket Head Button Screw	M8x30	2
95	PLAREVO1836-195	Socket Head Cap Screw	3/8-16UNCx1"	1
96	PLAREVO1836-196	Knob		1
97	PLAREVO1836-197	Socket Head Cap Screw	5/16-18UNCx1"	8
98	PLAREVO1836-198	Set Screw	5/16-18UNCx3/8	2
99	PLAREVO1836-199	Set Screw	M8x6	4
100	PLAREVO1836-1100	Set Screw	M4x4	2
101	PLAREVO1836-1101	Set Screw	1/4-20UNCx1/4	4
102	PLAREVO1836-1102	Key	5x5x50	1
103	PLAREVO1836-1103	Screw	M4x15	4
104	PLAREVO1836-1104	Screw	M3x8	6

Index	Part Number	Item Description	Specification	Qty
105	PLAREVO1836-1105	Flat Head Socket Screw	M3x8	2
106	PLAREVO1836-1106	Phillips Flat Head Screw	M6x16	4
107	PLAREVO1836-1107	Screw	M3x4	2
108	PLAREVO1836-1108	Motor Cord		1
109	PLAREVO1836-1109	Flat Washer	D3xD8x1t	2
110	PLAREVO1836-1110	Nylon Insert Lock Nut	M18x2.5	3
111	PLAREVO1836-1111	Hex Nut	3/8-16UNC	4
112	PLAREVO1836-1112	Flat Washer	D10xD23x2t	8
113	PLAREVO1836-1113	Flat Washer	D8xD18x2t	13
114	PLAREVO1836-1114	Lock Washer	5/16"	12
115	PLAREVO1836-1115	Lock Washer	3/8"	5
116	PLAREVO1836-1116	Phillips Flat Head Screw	3/8-16UNCx3/4"	4
117	PLAREVO1836-1117	Strain Relief	7N-2	3
118	PLAREVO1836-1118	Strain Relief	2P-4	1
119	PLAREVO1836-1119	Set Screw	1/4-20UNCx3/8	1
120	PLAREVO1836-1120	Socket Head Button Screw	M8x30	1
121	PLAREVO1836-1121	Socket Head Button Screw	M8x45	1
122	PLAREVO1836-1122	Socket Head Cap Screw	5/16-18UNCx1/2"	2
123	PLAREVO1836-1123	Poly-V Belt	PJ8-190	1
124	PLAREVO1836-1124	Set Screw	M6x6mm	1
125	PLAREVO1836-1125	Set Screw	5/16-18UNCx1/4	1
126	PLAREVO1836-1126	Socket Head Button Screw	3/8-16UNCx5/8"	2
127	PLAREVO1836-1127	Screw	M3x12	2
128	PLAREVO1836-1128	Spacer		2
129	PLAREVO1836-1129	Handle		2
130	PLAREVO1836-1130	Sensor Bracket		1
131	PLAREVO1836-1131	Phillips Flat Head Screw	M3x4	4
132	PLAREVO1836-1132	Knob		1
133	PLAREVO1836-1133	Screw	M3x4	1
134	480BS-1109A	Cover		1
135	PLAREVO1836-1135	Clamp		1
136	PLAREVO1836-1136	Handle, Faceplate		1
137	PLAREVO1836-1137	Logo Plate		1
138	PLAREVO1836-1138	Strain Relief	6N-4	4
139	PLAREVO1836-1139	Bracket		1
140	PLAREVO1836-1140	Thimble		1

Index	Part Number	Item Description	Specification	Qty
141	PLAREVO1836-1141	Socket Flat Head Screw	M3x8	1
142	PLAREVO1836-1142	Cord Holder		1
143	PLAREVO1836-1143	O-Ring	P29	1
144	PLAREVO1836-1144	Speed Label		1
145	PLAREVO1836-1145	Cap		4
146	PLAREVO1836-1146	Socket Head Button Screw	1/4-20UNCx3/8"	8
147	PLAREVO1836-1147	Headstock Bracket		1
148	PLAREVO1836-1148	Socket Head Cap Screw	3/8-16UNCx1-1/4"	2
149	PLAREVO1836-1149	Tailstock Bracket		1
150	PLAREVO1836-1150	Socket Head Cap Screw	3/8-16UNCx3/4"	2
151	PLAREVO1836-1151	Magnet		1
152	PLAREVO1836-1152	Screw	M4x6	2
153	PLAREVO1836-1153	Hex Nut	M4x0.7	1
154	PLAREVO1836-1154	Braking Resistor Cover		1
155	PLAREVO1836-1155	Set Screw	M6x12	2
156	PLAREVO1836-1156	O-Ring	P14	1
167	PLAREVO1836-1167	Adjusting Block		1
168	PLAREVO1836-1168	Adjusting Block		1
169	PLAREVO1836-1169	Socket Head Button Screw	3/16-24UNCx1"	4
170	415241-1128	Socket Head Button Screw	3/16-24UNCx1/2"	4
171	93267-2-302	Washer, Lock-Int. Tooth	M4	2

Warranty

This machine is covered by a warranty and the purchasing dealer can answer any questions you may have. Additionally, we will always be here to offer support.

Service: +1 (949) 474-1200

customerservice@lagunatools.com

Every product sold is warranted to be free of manufacturers' defective workmanship, parts, and materials. For any questions about this product, the intended use or what it was designed for, customer service, or replacement parts – please reach out to our customer service department.

Registration



To prevent voiding this warranty, all products sold must be registered within thirty (30) days of receiving. Registering the product will enable the original purchaser to receive notifications about important product changes and receive customer support.

<https://lagunatools.com/policies/warranty/>

What Is Covered?

Any part, determined by Laguna Tools®, to have a defect will be repaired or replaced (and shipped), without charge. It is required that the defective item/part be returned to Laguna Tools® with the complaint and proof of purchase in the original packaging that it was received. In the event the item/part is determined to be void of this warranty, the customer will be responsible for the cost to replace the item/part and all related shipping charges.

Who Is Covered?

The applicable warranty covers only the initial purchaser of the product from the receipt date. The original purchaser must present the original receipt as proof of purchase.

Shipping Damage

Laguna Tools® and the purchasing customer is not responsible for damage or loss caused by a freight company or other circumstances not in the direct control of Laguna Tools®. All shipping related claims for loss or damaged goods must be made to Laguna Tools within twenty-four hours of delivery.

Warranty Limitations

This limited warranty does not apply to natural disasters, acts of terrorism, normal wear and tear, product failure due to lack of maintenance or cleaning, damage caused by accident, neglect, or lack-of/inadequate dust collection. The warranty may be voided against proof of misuse/abuse, damage caused where repair or alterations have been made or attempted by others, using the product for purposes other than those described as intended use (unless with consent by Laguna Tools®), modification to the product, or use with an accessory that was not designed for the product. It is the responsibility of the user to understand basic woodworking machinery settings and procedures and to properly maintain the equipment in accordance with the standards provided in this manual.

Length of Warranty

Aside from being free of defects upon receiving, consumable parts, like cutters and abrasives, are not covered by this warranty unless otherwise stated by Laguna Tools®. These parts are designed to be used at the expense of the operator and are available for replacement or inventory purchase.

2 Year – New purchases through authorized dealers.

1 Year – New purchases directly from Laguna Tools.

1 Year – Blades and Accessories

LAGUNA

LAGUNA AMERICAN HEADQUARTERS

Texas: 744 Refuge Way Suite 200, Grand Prairie, Texas 75050, U.S.A. Phone: +1-800-332-4094

Huntington Beach: 7291 Heil Ave Huntington Beach, CA 92647, U.S.A. Phone: +1-949-474-1200

South Carolina: 825 Bistline Dr. Ste 101, West Columbia, SC 29172, U.S.A. Phone: +1-800-234-1976

Minnesota: 5250 West 74th St, Edina, MN 55439, U.S.A Phone: +1-949-474-1200

DAKE CORPORATION

724 Robbins Road, Grand Haven, MI 49417, United States +1-800-937-3253

LAGUNA EUROPE

Walker Rd, Bardon Hill, Coalville LE67 1TU, United Kingdom. Phone: +44-1530-516921

© 2020 Laguna Tools