

SCHLAGE®

A-SERIES

Heavy Duty Residential and Medium Duty Commercial



*Heavy Duty Residential and
Medium Duty Commercial*

*For interior doors of multi-family dwellings and
military facilities. Also ideal for exterior doors of
fine homes.*

Performance Features

Cold rolled steel, machined, threaded hubs and locking nuts prevent loosening of the lockset by bolting chassis to the door.

Heavy duty cast mounting plate with specially tapped holes keeps lockset tight on door. Large diameter of mounting plate and rose covers new ANSI hollow metal door cutout.

Patented door range adjuster allows quick and easy adjustment of the AL-Series for 1 3/8" to 1 7/8" (35 mm to 48 mm) thick doors.

INDEX	
Cylinders	4 - 5
Designs & Finishes	2
Door Preparation	1
Functions	3
How to Order	8
Interchangeable Core	4 - 5
Latches	6
Primus® High Security Cylinders	4
Specifications	1
Strikes	7

Exploded View

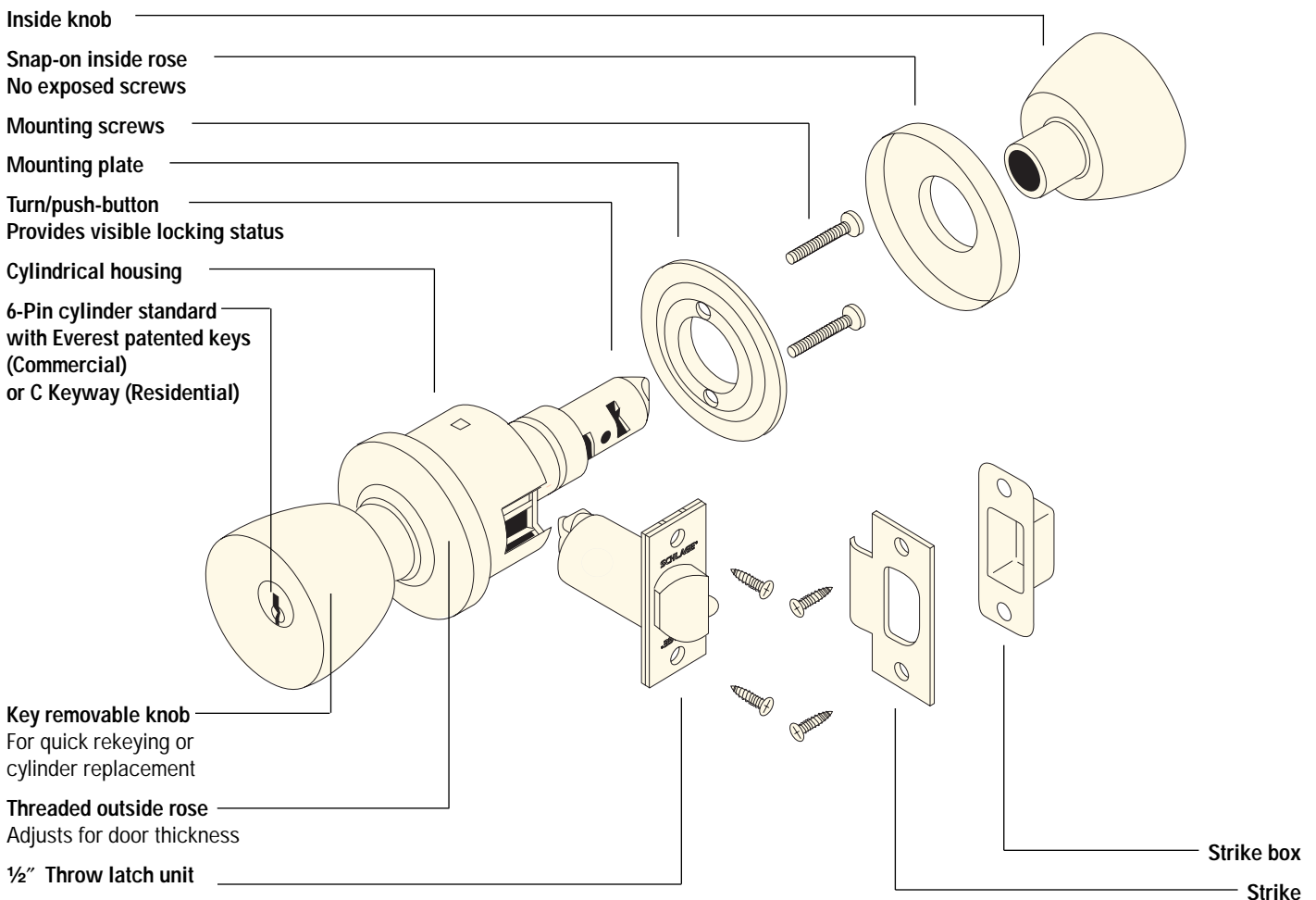

On our cover, the A-Series PLYMOUTH in Bright Brass.

Specifications

Handing:

Keyed functions are reversible. Non-keyed functions are not handed.

Door Thickness:

1 $\frac{3}{8}$ " to 1 $\frac{7}{8}$ " (35 mm to 48 mm) standard.
2" (51 mm) to 2 $\frac{1}{2}$ " (64 mm) optional extended inside.

Backset:

2 $\frac{3}{8}$ " (60 mm) standard. 2 $\frac{3}{4}$ " (70 mm), 3 $\frac{3}{4}$ " (95 mm) and 5" (127 mm) optional.

Front:

Steel. 1 $\frac{1}{8}$ " x 2 $\frac{1}{4}$ " square corner, beveled, for 2 $\frac{3}{4}$ " backset standard. Optional 1" square corner, 1" radius corner, and non-UL drive-in / round face. For availability with specific backsets, see page 6.

Lock Chassis:

Steel, zinc dichromate plated for corrosion resistance.

Latch Bolt:

Brass, chrome plated, $\frac{1}{2}$ " throw, deadlocking on keyed and exterior functions.

Exposed Trim:

Wrought brass, bronze or stainless steel. Levers are pressure cast zinc, plated to match finish symbols.

Strike:

T-strike 1 $\frac{1}{8}$ " x 2 $\frac{3}{4}$ " (29 mm x 70 mm) x 1 $\frac{1}{8}$ " (29 mm) lip to center with box standard. Optional strikes, lip lengths and ANSI strike box available. See page 7.

Cylinder & Keys:

Commercial: 6-pin patented Everest C123 keyway standard with two nickel silver keys per lock.

Residential: 6-pin C keyway, keyed 5-pin.

Keying Options:

Interchangeable core and Primus® high security cylinders. Master keying, grand master keying, and construction keying.

Warranty:

Commercial: three-year limited.

Residential: Full mechanical lifetime.

Door Preparation

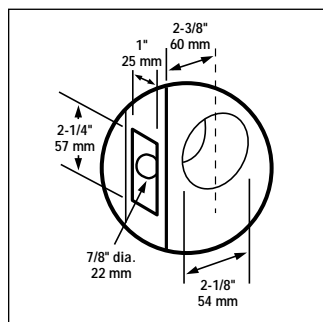

Certifications

ANSI

Meets or exceeds A156.2 Series 4000, Grade 2 strength and operational requirements.

Federal

Meets FF-H-106C.

California State Reference Code

(Formerly Title 19, California State Fire Marshal Standard)

All levers with returns comply; levers return to within $\frac{1}{2}$ " of door face.

UL / ULC:

All locks listed for A label single doors, 4' x 8'. Letter F and UL symbol on latch front indicate listing. UL437 Listed locking cylinder optional: specify Primus 20-500 Series cylinder.



Designs & Finishes



609

GEORGIAN

Symbol: GEO
Material: Wrought brass
Finishes: 605, 606,
609, 610,
625, 626

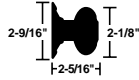

605

LEVON

Symbol: LEV
Material: Pressure cast
zinc lever; wrought brass
or bronze rose
Finishes: 605, 612,
613, 626

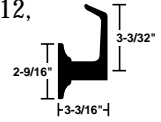

613

ORBIT

Symbol: ORB
Material: Wrought brass
or bronze
Finishes: 605, 606, 609,
610, 611, 612, 613,
616, 625, 626

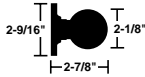

*Note: Levon available as
inside trim only on deadlatch
functions. Specify complete
trim application and door
handing when ordering with
deadlatch functions.*

Finishes

- 605 Bright Brass
- 606 Satin Brass
- 609 Antique Brass
- 610 Bright Brass, Blackened
- 611 Bright Bronze
- 612 Satin Bronze
- 613 Oil Rubbed Bronze
- 616 Antique Bronze
- 625 Bright Chromium Plated
- 626 Satin Chromium Plated
- 629 Bright Stainless Steel
- 630 Satin Stainless Steel



605

PLYMOUTH

Symbol: PLY
Material: Wrought brass,
bronze, or stainless steel
Finishes: 605, 606, 609, 610,
611, 612, 613, 616, 625,
626, 629, 630

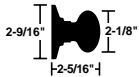

626

TULIP

Symbol: TUL
Material: Wrought brass
Finishes: 605, 606,
609, 610,
625, 626

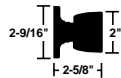

Keyed functions available with full size interchangeable core option for Orbit design.

Functions

ANSI A156.2 Series 4000 Grade 2

Non-Keyed Functions

SCHLAGE ANSI

A10S F75

Passage Latch

Both knobs always unlocked.

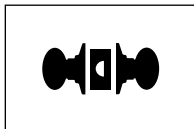

A25D

Exit Lock

Blank plate outside. Inside knob always unlocked. Specify door thickness, 1 $\frac{3}{8}$ " or 1 $\frac{3}{4}$ ".

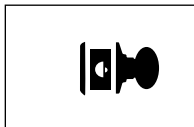

A30D F77

Patio Lock

Push-button locking. Turning inside knob or closing door releases button, preventing lock-out.

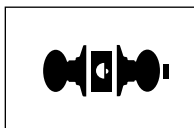

A40S F76

Bath/Bedroom Privacy Lock

Push-button locking. Can be opened from outside with small screwdriver. Turning inside knob or closing door releases button.

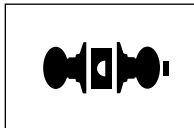

A43D F79

Communicating Lock

Turn-button in outer knob locks and unlocks knob and inside thumbturn.

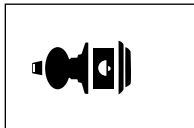

A170

Single Dummy Trim

Dummy trim for one side of door. Used for door pull or as matching inactive trim.

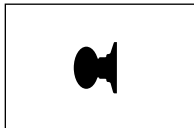

Keyed Functions

SCHLAGE ANSI

A53PD F109

Entrance Lock

Turn/push-button locking; pushing and turning button locks outside knob requiring use of key until button is manually unlocked. Push-button locking; pushing button locks outside knob until unlocked by key or by turning inside knob.

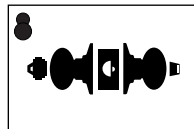

A70PD F84

Classroom Lock

Outside knob locked and unlocked by key. Inside knob always unlocked.

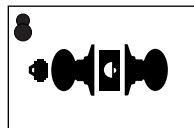

A79PD

Communicating Lock

Locked or unlocked by key from outside. Blank plate inside.

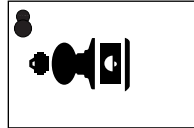

A80PD F86

Storeroom Lock

Outside knob fixed. Entrance by key only. Inside knob always unlocked.

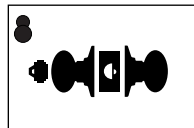

A85PD F93

Hotel/Motel Lock

Outside knob fixed. Entrance by key only. Push-button in inside knob activates visual occupancy indicator, allowing only emergency masterkey to operate. Rotation of inside spanner-button provides lock-out feature by keeping indicator thrown.

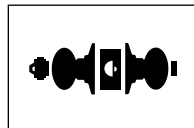

 Keyed functions available with full size interchangeable core option for Orbit design.

Standard Cylinders

Schlage® locks are provided with cylinders precision built to extremely close tolerances and the highest standards of accuracy. Using only solid brass plugs, extruded brass shells, phosphor bronze springs, nickel silver keys and pins, ensures long life and ease of operation. For complete listing of cylinder parts, refer to the A-Series Service Manual.

Conventional cylinders are available in Classic keyways or in the newly patented Everest® keyways. Specify keyway to differentiate between Everest and Classic. Example: C (Classic) vs. C123 (Everest).

Primus® High Security Cylinders

Primus high security cylinders are available to add patented key control and varying degrees of geographical exclusivity to most Schlage 6-pin key systems, whether Everest or Classic keyways.

In addition to a conventional pin tumbler mechanism, Primus cylinders incorporate a patented finger pin and sidebar design providing a “dual-locking” cylinder that is virtually pick-proof. Resistance to drilling and other physical attack is optional by specifying 20-500 Series UL437 Listed cylinders.

Classic Primus cylinders are recommended for upgrading existing Classic key systems. Due to its extended patent life, the newly designed Everest Primus is recommended for new key systems and for upgrading existing Everest® key systems. Specify keyway to differentiate between Everest and Classic. Example: CP (Classic) vs. C123 (Everest).

Cylinder for Most Functions

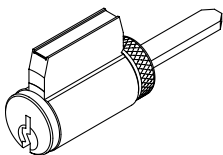

Hotel Function Indicator Cylinder

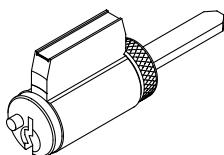

Standard Cylinders

Number		Description
Orbit Design	Other Designs	
21-002-122	21-002	6-Pin conventional (standard)
20-724-122	20-724	Primus high security
20-524-122	20-524	Primus UL437 Listed high security
21-003-168	21-003	Hotel Function (A85) with indicator

Available 606 and 626 finish only. Everest C123 keyway standard for Commercial; C keyway standard for residential.

Interchangeable Core



Schlage® figure-8 interchangeable core (IC) locksets allow immediate rekeying at the door simply by using the special *control key* to replace the core in seconds.

IC locksets are available in Orbit design only.

ORBIT

Symbol: ORB
Material: Wrought brass or bronze
Finishes: 605, 606, 612, 613, 625, 626



626

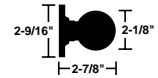

Full size interchangeable cores can be integrated into any 5 or 6-pin Schlage key with no adverse affects on keying capacity.

To order complete locks with full size cores, change suffix from PD to RD. Example: A53RD. To order locks *less core*, change suffix to JD. To order with full size *construction core*, change suffix to TD.

Note: Hotel function A85PD is not available with interchangeable cores.

Cores Only

Full Size Core

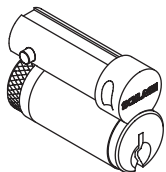

Full Size Interchangeable Cores (For JD Suffix Locksets)

Number	Description
23-030	Conventional core
20-740	Primus high security core

Available 606 and 626 finish only. Everest C123 keyway standard for Commercial; C keyway standard for residential.

Driver and Retainer

01-053

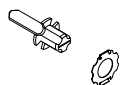

Required for upgrading IC locks manufactured before 1992 to accept Everest and Primus cores.

IC Installation Tool

This tool is used to install the driver and retainer for full size IC in the A-Series and other Schlage cylindrical locksets. Its other ends are designed to install and remove mortise cylinder housings and test mortise cylinder cam action for both small format and full size interchangeable core cylinders.

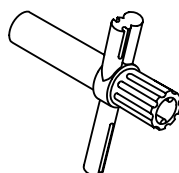

M504-413
(Order separately.)

IC Conversion Kits

It is easy to convert standard A-Series locksets to accept Schlage full size interchangeable cores by changing the knob and adding the parts shown.

Full Size IC Conversion

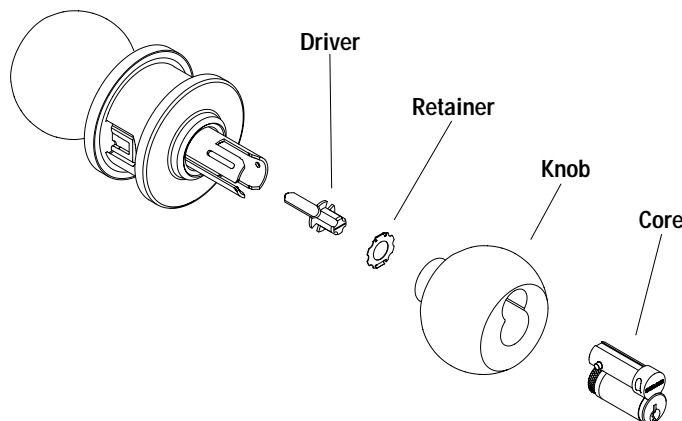

Interchangeable Core Components

Number	Description
01-054 ORB	Conversion kit: Driver, retainer, knob, core
01-025 ORB	Conversion kit: Driver, retainer, knob
01-026 ORB	Knob only (Orbit)

Specify finish.

Latches

A-Series latches are adjustable for flat or beveled edge doors. Latches and strikes are furnished in brass, bronze, or chrome finishes compatible with lock trim. When ordering separately, specify quantity, part number, and finish.

Square Corner Latches

Springlatch

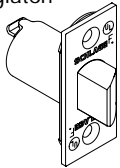

Deadlatch

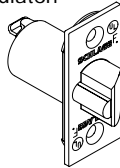

Round Corner Latches

Springlatch

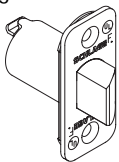

Deadlatch

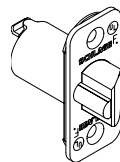

Drive-In Latches

Springlatch

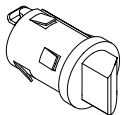

Deadlatch

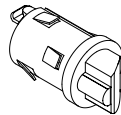

Latch Front Adapter

A501-878

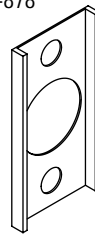

Used to convert 1" wide square front faceplates for 1 1/8" wide door preparations. Furnished in black plastic. Order in units of 100 each.

Long Backsets

Backsets 5" and over require extension links. AL-Series locks with long backsets are normally furnished with 1" faceplates and 7/8" housings. Links installed in 1" latch holes require one G506-815 sleeve (order separately) to join latch and link. Backsets over 5" require an additional sleeve placed 1/8" from lock chasis. Information on longer backsets is available upon request.

5" Extension Link

41-005
(add to 2 3/8" backset latch)

Sleeve

G506-815
(Order separately)

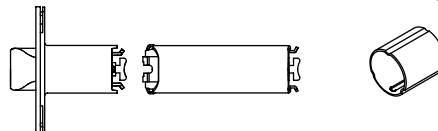

Latches

Backset	Faceplate Description	Hsg Dia	Springlatch 1/2" (13mm) Throw	Deadlatch 1/2" (13mm) Throw
2 3/8" (60mm)	1" x 2 1/4" (25mm x 57mm) square corner, standard	7/8" (22mm)	11-068	11-085
	1" x 2 1/4" (25mm x 57mm) 1/4" (6mm) radius rnd. cnr.	7/8" (22mm)	11-069	11-088
	1" (25mm) circular drive-in (non-U.L.)	1" (25mm)	11-110	11-104
2 3/4" (70mm)	1" x 2 1/4" (25mm x 57mm) square corner	7/8" (22mm)	11-111	11-091
	1 1/8" x 2 1/4" (29mm x 57mm) square corner	1" (25mm)	11-116	11-096
	1" x 2 1/4" (25mm x 57mm) 1/4" (6mm) radius rnd. cnr.	7/8" (22mm)	11-112	11-092
	1" (25mm) circular drive-in (non-U.L.)	1" (25mm)	11-113	11-105
3 3/4" (95mm)	1 1/8" x 2 1/4" (29mm x 57mm) square corner	1" (25mm)	11-118	11-103

Door Reinforcement

Schlage® 37-001 reinforcing unit is used to reinforce and help prevent the collapse of hollow metal doors when locksets are tightly mounted.

This kit should be used with long backsets for A-Series lock installations in hollow metal doors to prevent lateral movement of the latchbolt. Specify door thickness, 1 3/8" (35mm) or 1 3/4" (44mm), when ordering reinforcement kits.

Door Prep

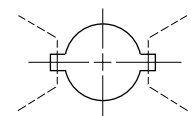

Reinforcement Kit 37-001

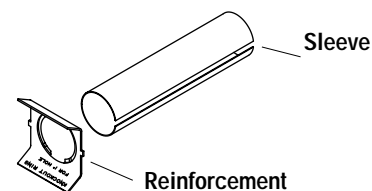

A501-566
1 3/4" (44mm) Doors

A501-565
1 3/8" (35mm) Doors

Strikes

All Schlage strikes are furnished complete with screws. The 10-001 standard A-Series strike has a 1 1/8" (29 mm) lip. When ordering separately, specify quantity, product number, finish, and lip length.

Strikes

Number	Lip Length	Description
10-001	1", 1 1/8" (Std), 1 1/4", 1 1/2", 1 3/4", 2" (25 mm, 29 mm, 32 mm, 38 mm, 44 mm, 51 mm)	1 1/8" x 2 3/4" (29 mm x 70 mm) Square corner, standard
10-004	1 1/8" (29 mm)	1 1/8" x 2 3/4" (29 mm x 70 mm) 1/8" (3 mm) Radius, round cnr.
10-025	1 3/16", 1 3/8" (30 mm, 35 mm)	1 1/4" x 4 7/8" (32 mm x 124 mm) ANSI
10-026	1 1/8" (29 mm)	1 5/8" x 2 1/4" (41 mm x 57 mm) Full lip, square corner
10-027	1 1/8" (29 mm)	1 5/8" x 2 1/4" (41 mm x 57 mm) Full lip, 1/4" (6 mm) radius, round corner
10-058	1 7/32" (31 mm)	1 3/4" (44 mm) Circular, adjustable
K510-066	—	Box, ANSI
39-030*	—	Rabbeted door adapter kit

*Use with 2 3/4" square corner strikes only.

T-Strike – Standard

10-001

1 1/8" x 2 3/4" x 3/32"

(29 mm x 70 mm x 2 mm)

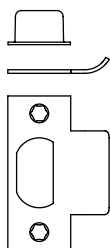

ANSI Strike

10-025

1 1/4" x 4 7/8" x 3/32"

(32 mm x 124 mm x 2 mm)

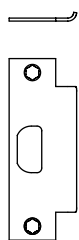

Rabbeted Latch and Strike Kit

Rabbeted latch and strike kit finishes: 605, 626.

This kit adapts square corner latches and strikes for 1/2" (13 mm) rabbeted door and frame preparations.

Rabbeted Latch and Strike Kit 39-030

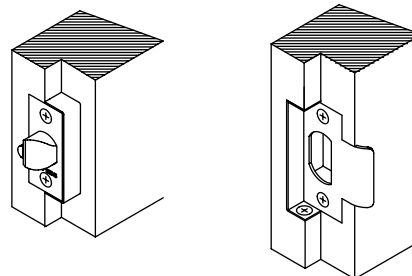

Door Handing

All Schlage locks are reversible. Hand information is necessary to ensure proper cylinder orientation in keyed functions, and finish of latchbolt and strike for locks that are to be installed on reverse bevel doors. Follow the diagram to correctly determine the hand of the door.

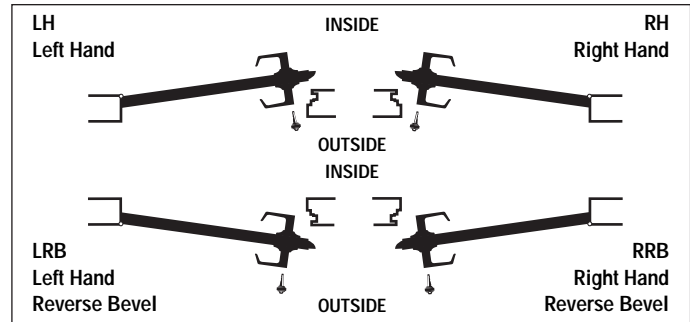

How to Order

To order Schlage products, descriptive data should be in the same sequence as shown.

Line Item	Qty	Product	Outside		Inside		Hand	Latch	Strike	DR Thk	Ext	Dim	Additional Details
			Des	Fin	Des	Fin							
1	2	3	4	5	6	7	8	9	10	11	12	13	14

- 1 Line item number
- 2 Quantity
- 3 Complete model number with function and cylinder type

To order cylinder options, change "PD" at the end of the model number as follows:

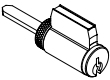
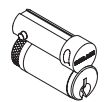
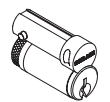
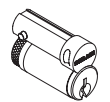
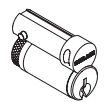
	A53PD	Standard
	A53LD	Less standard cylinder (For Primus cylinder, specify this option and order Primus cylinder separately.)
	A53JD	Prepared for full size interchangeable core, less core
	A53RD	With full size conventional interchangeable core installed. Order control keys separately.
	A53TD	With full size (temporary) construction core installed. Order all keys separately.

- 4/5 Outside design / finish.
- 6/7 Inside design / finish. Leave blank if same as outside.
- 8 Hand
- 9 Latch. Leave blank for standard or specify part number for optional latch. LLL=Less Latch.
- 10 Strike. Leave blank for standard or specify part number for optional strike. LLL=Less Strike.
- 11 Door thickness, if non-standard. Example: 200 = 2".
- 12 Dimension for strike lip lengths. See strike page for availability of specific dimensions with specific strikes.
 - 100 = 1"
 - 118 = 1 1/8"
 - 114 = 1 1/4"
 - 138 = 1 3/8"
 - 112 = 1 1/2"
 - 134 = 1 3/4"
 - 200 = 2"
- 13 Keying detail (e.g. key symbol, keyway, bitting) and other special requirements.

EXAMPLE

Line Item	Qty	Product	Outside		Inside		Hand	Latch	Strike	Dr Thk	Ext	Dim	Additional Details
			Des	Fin	Des	Fin							
1	100	A53PD	PLY	626			RH	11-096	10-025				1AA-100AA
2	200	A53LD	PLY	626				11-096	10-025				Less Cylinder
3	200	20-724		626									1AA-200AA

Note: Schlage order forms are available at no charge by contacting your IR Security & Safety Consultant or Customer Service.

Administrative Offices

1915 Jamboree Drive, Suite 165
Colorado Springs, CO 80920
(719) 264-5300
FAX (719) 264-5382

Commercial Customer Service

2315 Briargate Parkway, Suite 700
Colorado Springs, CO 80920
(800) 847-1864
FAX (800) 452-0663
Order Entry
FAX (800) 452-0665

Residential Customer Service

P.O. Box 1210
Olathe, KS 66051
(800) 847-1864
FAX (800) 366-3625

International Division

Ingersoll-Rand Architectural Hardware
1076 Lakeshore Road East
Mississauga, Ontario, L5E 1E4, Canada
(905) 278-6128
FAX (905) 278-1413

Internet

<http://www.schlage.com>

Fax-On-Demand

(888) 321-3228

IR Security & Safety Americas

111 Congressional Boulevard
STE 200
Carmel, IN 46032
800-847-1864
800-452-0663 Fax
www.irsecurityandsafety.com

An  **Ingersoll-Rand** business

 **Security & Safety**
Proven Source. Proven Solutions.™